

DENON *PROFESSIONAL*

AV SURROUND PREAMPLIFIER

DN-A7100

USER GUIDE

BEDIENUNGSANLEITUNG

MODE D'EMPLOI

GUIDA DELL'UTENTE

GUÍA DEL USUARIO

GEBRUIKSAANWIJZING

GUIA DO UTILIZADOR

BRUKSANVISNING

ENGLISH

WARRANTY

For warranty information, contact your local DENON distributor.

RETAIN YOUR PURCHASE RECEIPT

Your purchase receipt is your permanent record of a valuable purchase. It should be kept in a safe place to be referred to as necessary for insurance purposes or when corresponding with DENON.

IMPORTANT

When seeking warranty service, it is the responsibility of the consumer to establish proof and date of purchase. Your purchase receipt or invoice is adequate for such proof.

FOR U.K. ONLY

This undertaking is in addition to a consumer's statutory rights and does not affect those rights in any way.

DEUTSCH

GARANTIE

Bei Garantiefragen wenden Sie sich bitte an Ihren DENON-Händler.

HEBEN SIE IHRE QUITTING GUT AUF

Die Quittung dient Ihnen als bleibende Unterlage für Ihren wertvollen Einkauf. Das Aufbewahren der Quittung ist wichtig, da die darin enthaltenen Angaben für Versicherungszwecke oder bei Korrespondenz mit DENON angeführt werden müssen.

WICHTIG!

Bei Garantiefragen muß der Kunde eine Kaufunterlage mit Kaufdatum vorlegen. Ihren Quittung oder Rechnung ist als Unterlage ausreichend.

FRANÇAIS

GARANTIE

Pour des informations sur la garantie, contacter le distributeur local DENON.

CONSERVER L'ATTESTATION D'ACHAT

L'attestation d'achat est la preuve permanente d'un achat de valeur. La conserver en lieu sûr pour s'y reporter aux fins d'obtention d'une couverture d'assurance ou dans le cadre de correspondances avec DENON.

IMPORTANT

Pour l'obtention d'un service couvert par la garantie, il incombe au client d'établir la preuve de l'achat et d'en corroborer la date. Le reçu ou la facture constituant des preuves suffisantes.

ITALIANO

GARANZIA

L'apparecchio è coperto da una garanzia di buon funzionamento della durata di un anno, o del periodo previsto dalla legge, a partire dalla data di acquisto comprovata da un documento attestante il nominativo del Rivenditore e la data di vendita. La garanzia sarà prestata con la sostituzione o la riparazione gratuita delle parti difettose.

Non sono coperti da garanzia difetti derivanti da uso improprio, errata installazione, manutenzione effettuata da personale non autorizzato o, comunque, da circostanze che non possano riferirsi a difetti di funzionamento dell'apparecchio. Sono inoltre esclusi dalla garanzia gli interventi inerenti l'installazione e l'allacciamento agli impianti di alimentazione.

Gli apparecchi verranno riparati presso i nostri Centri di Assistenza Autorizzati. Le spese ed i rischi di trasporto sono a carico del cliente.

La casa costruttrice declina ogni responsabilità per danni diretti o indiretti provocati dalla inosservanza delle prescrizioni di installazione, uso e manutenzione dettagliate nel presente manuale o per guasti dovuti ad uso continuato a fini professionali.

ESPAÑOL

GARANTIA

Para obtener información acerca de la garantía póngase en contacto con su distribuidor DENON.

GUARDE SU RECIBO DE COMPRA

Su recibo de compra es su prueba permanente de haber adquirido un aparato de valor. Este recibo deberá guardarlo en un lugar seguro y utilizarlo como referencia cuando tenga que hacer uso del seguro o se ponga en contacto con DENON.

IMPORTANTE

Cuando solicite el servicio otorgado por la garantía el usuario tiene la responsabilidad de demostrar cuándo efectuó la compra. En este caso, su recibo de compra será la prueba apropiada.

NEDERLANDS

GARANTIE

Voor inlichtingen omtrent garantie dient u zich tot uw plaatselijke DENON.

UW KWITANTIE, KASSABON E.D. BEWAREN

Uw kwitantie, kassabon e.d. vormen uw bewijs van aankoop van een waardevol artikel en dienen op een veilige plaats bewaard te worden voor evt. verwijzing bij, in verband met verzekering of bij correspondentie met DENON.

BELANGRIJK

Bij een evt. beroep op de garantie is het de verantwoordelijkheid van de consument een gedateerd bewijs van aankoop te tonen. Uw kassabon of factuur zijn voldoende bewijs.

PORTUGUÊS

GARANTIA

Para informações sobre a garantia, contactar o distribuidor DENON local.

GUARDAR O RECIBO DE COMPRA

O recibo é o registo permanente da compra que fez. Deve ser guardado num local seguro, para ser apresentado em questões relacionadas com o seguro ou para quando tiver de contactar a DENON.

IMPORTANTE

Quando procurar assistência técnica ao abrigo da garantia, é da responsabilidade do consumidor estabelecer a prova e data de compra. O recibo é prova adequada.

SVENSKA

GARANTI

För information om garantin, kontakta DENON lokalagent.

SPAR KVITTOT

Kvittot är ett inköpsbevis på en värdefull vara. Det skall förvaras säkert och hänvisas till vid försäkringsfall eller vid korrespondens med DENON.

VIKTIGT

Fö att garantin skall gälla är det kundens sak att framställa bevis och datum om köpet. Kvitto eller faktura är tillräckligt bevis för detta.

CE MARKING



English

The DN-A7100 is in conformity with the EMC directive and low-voltage directive.



Deutsch

Das Modell DN-A7100 entspricht den EMC-Richtlinien und den Richtlinien für Niederspannungsgeräte.



Français

Le DN-A7100 est conforme à la directive EMC et à la directive sur les basses tensions.



Italiano

Il DN-A7100 è conforme alle direttive CEE ed a quelle per i bassi voltaggi.



Español

El DN-A7100 está de acuerdo con las normas EMC y las relacionadas con baja tensión.



Nederlands

De DN-A7100 voldoet aan de EMC eisen en de vereisten voor laag-voltage.



Português

O DN-A7100 conforma com as diretrizes EMC e de baixa voltagem.



Svenska

DN-A7100 är tillverkad i enlighet med EMC direktiven och direktiven för lågvoltstrusning.

English

WARNINGS

- Do not expose the equipment to rain or moisture.
- Do not remove the cover from the equipment.
- Do not insert anything into the equipment through the ventilation holes.
- Do not handle the mains cord with wet hands.
- Do not cover the ventilation with any items such as tablecloths, newspapers, curtains, etc.
- No naked flame sources, such as lighted candles, should be placed on the equipment.
- When disposing of used batteries, please comply with governmental regulations or environmental public instruction's rules that apply in your country or area.
- Make a space of about 0.2 meter around the unit.
- No objects filled with liquids, such as vases, shall be placed on the equipment.
- When the switch is in the OFF position, the equipment is not completely switched off from MAINS.
- The equipment shall be installed near the power supply so that the power supply is easily accessible.
- Do Not Touch Hot Spots During and Immediately After Use.
- During and immediately after use, this product is hot in areas other than the controls and rear panel connection jacks. Do not touch hot spots and especially the top panel. Contact with hot areas can cause burns.

Deutsch

WARNHINWEISE

- Das Gerät nicht Regen oder Feuchtigkeit aussetzen.
- Die Abdeckung nicht vom Gerät abnehmen.
- Keine Gegenstände durch die Belüftungsschlitze stecken.
- Das Netzkabel nicht mit feuchten oder nassen Händen anfassen.
- Decken Sie die Lüftungsöffnungen nicht mit einem Tischtuch, einer Zeitung, einem Vorhang usw. ab.
- Es dürfen keine Gegenstände mit offener Flamme, wie etwa brennende Kerzen, auf dem Gerät aufgestellt werden.
- Beachten Sie bei der Entsorgung der verbrauchten Batterien alle geltenden lokalen und überregionalen Regelungen.
- Auf allen Geräteseiten muß ein Zwischenraum von ungefähr 0,2 meter vorhanden sein.

- Auf das Gerät dürfen keine mit Flüssigkeiten gefüllte Behälter, wie etwa eine Vase, gestellt werden.
- Wenn der Schalter ausgeschaltet ist (OFF-Position), ist das Gerät nicht vollständig vom Stromnetz (MAINS) abgetrennt.
- Das Gerät sollte in der Nähe einer Netzsteckdose aufgestellt werden, damit es leicht an das Stromnetz angeschlossen werden kann.
- Berühren Sie während oder unmittelbar nach dem Gebrauch keine heißen Stellen des Gerätes.
- Während oder unmittelbar nach dem Gebrauch ist dieses Produkt mit Ausnahme der Bedienelemente und der Anschlussbuchsen auf der Rückseite heiß. Berühren Sie die heißen Stellen und insbesondere die Oberseite nicht. Der Kontakt mit heißen Flächen kann zu Verbrennungen führen.

Français

AVERTISSEMENTS

- Ne pas exposer l'appareil à la pluie ni à l'humidité.
- Ne pas essayer de retirer le boîtier de l'appareil.
- Ne rien insérer dans l'appareil par les orifices de ventilation.
- Ne pas manipuler le cordon d'alimentation avec les mains mouillées.
- Ne pas recouvrir les ouïes de ventilation avec un objet quelconque comme une nappe, un journal, un rideau, etc.
- Ne placer aucune source de flamme nue, comme une bougie allumée, sur l'appareil.
- Pour mettre au rebut les piles usées, respecter les lois gouvernementales ou les règlements officiels concernant l'environnement qui s'appliquent à votre pays ou région.
- Veiller à ce qu'aucun objet ne soit à moins de 0,2 mètre des côtés de l'appareil.
- Aucun objet rempli de liquide, un vase par exemple, ne doit être placé sur l'appareil.
- Lorsque l'interrupteur est sur la position OFF, l'appareil n'est pas complètement déconnecté du SECTEUR (MAINS).
- L'appareil sera installé près de la source d'alimentation, de sorte que cette dernière soit facilement accessible.
- Ne pas toucher aux zones chaudes pendant et immédiatement après l'utilisation.
- Pendant l'utilisation et immédiatement après, cet appareil est chaud en dehors des commandes et des prises de raccordement arrière. Ne pas toucher aux zones chaudes, et particulièrement au panneau supérieur, pour éviter tout risque de brûlure.

Italiano

AVVERTENZE

- Non esporre l'apparecchio alla pioggia o all'umidità.
- Non rimuovere il coperchio dell'apparecchio.
- Non introdurre oggetti all'interno dell'apparecchio attraverso i fori di ventilazione.
- Non toccare il cavo di alimentazione con le mani bagnate.
- Non coprire le fessure di ventilazione con tovaglie, giornali, tende od oggetti analoghi.
- Non posare sull'apparecchio sorgenti di fiamme scoperte quali candele accese.
- Smaltire le pile usate in conformità alle norme governative o disposizioni ambientali vigenti nel proprio paese o zona.
- Lasciare 0,2 metro liberi tutto intorno l'unità.
- Non mettere sull'apparecchiatura alcun contenitore di liquido, come ad esempio dei vasi.
- Quando l'interruttore è nella posizione OFF, l'apparecchiatura non è completamente scollegata da MAINS.
- L'apparecchio va installato in prossimità della fonte di alimentazione, in modo che quest'ultima sia facilmente accessibile.
- Non toccare i punti caldi né durante, né immediatamente dopo l'uso.
- Durante, e subito dopo l'utilizzo, questo prodotto risulta essere molto caldo in alcune sue parti come ad esempio i connettori del pannello posteriore. Non toccare i punti caldi e specialmente la superficie del pannello. Il contatto con parti calde può provocare ustioni.

Español

ADVERTENCIAS

- No exponga el equipo a la lluvia ni a la humedad.
- No extraiga la tapa del equipo.
- No introduzca nada en el interior del equipo a través de los orificios de ventilación.
- No maneje el cable de alimentación con las manos mojadas.
- No cubra la ventilación con objetos como manteles, periódicos, cortinas, etc.
- No deben colocarse sobre el equipo elementos con fuego, por ejemplo velas encendidas.
- Cuando se eliminen baterías usadas, deben cumplirse las reglamentaciones oficiales o las normas de protección medioambiental aplicables en su país o en su zona.
- Deje un espacio de unos 0,2 metro alrededor de la unidad.

- No se deben colocar sobre el aparato recipientes que contengan líquidos, como por ejemplo jarrones.
- Cuando el interruptor está en la posición OFF, el equipo no está completamente desconectado de la alimentación MAINS.
- El equipo se instalará cerca de la fuente de alimentación de manera que resulte fácil acceder a ella.
- No tocar las áreas calientes mientras la unidad está en uso ni inmediatamente después.
- Mientras esta en funcionamiento e inmediatamente después de su uso, este producto presenta zonas calientes en diversas partes, no exclusivamente en el sector de los controles o en las conexiones del panel posterior. No tocar las áreas calientes, especialmente el panel superior dado que pueden producirse quemaduras.

Nederlands

WAARSCHUWINGEN

- Stel het apparaat niet bloot aan regen of vocht.
- Verwijder de afdekplaat van het apparaat niet.
- Duw niets door de ventilatieopeningen in het apparaat.
- Raak het netsnoer niet met natte handen aan.
- Bedek de ventilatieopeningen niet met enige voorwerpen, zoals tafelkleden, kranten, gordijnen, enz.
- Plaats geen brandende voorwerpen, zoals kaarsen, op het apparaat.
- Volg bij het weggooien van verbruikte batterijen de overheidswetgeving of milieuvoorschriften op die van kracht zijn in het land of de regio waarin u zich bevindt.
- Zorg dat er 0,2 meter vrije ruimte rond het toestel is.
- Plaats geen voorwerpen met een vloeistof erin, zoals een bloemenvaas, op het apparaat.
- Als de schakelaar op OFF staat, is het apparaat niet volledig losgekoppeld van de netspanning (MAINS).
- De apparatuur wordt in de buurt van het stopcontact geïnstalleerd, zodat dit altijd gemakkelijk toegankelijk is.
- Raak hete gedeelten van het apparaat niet aan tijdens en onmiddellijk na het gebruik.
- Tijdens en onmiddellijk na het gebruik is dit product heet, behalve in de omgeving van de bedieningstoetsen en de aansluitingen op het achterpaneel. Raak geen hete plekken aan, vooral niet het bovenpaneel. Contact met hete plekken kan brandwonden veroorzaken.

Português

ADVERTÊNCIAS

- Não exponha o equipamento à chuva nem à humidade.
- Não retire a tampa do equipamento.
- Não atire nada para dentro do equipamento através dos orifícios de ventilação.
- Não manuseie o cabo de alimentação com as mãos molhadas.
- Não cobrir os orifícios de ventilação com objectos tais como toalhas de mesa, jornais, cortinas, etc.
- Não colocar chamas abertas tais como velas acesas, sobre o aparelho.
- Ao deitar foras as pilhas usadas, favor observar os regulamentos governamentais ou as regras com respeito ao meio ambiente que se aplicam no seu país ou área de residência.
- Deixar um espaço de cerca de 0,2 metro ao redor do aparelho.
- Não colocar objectos com líquidos, como vasos, em cima do equipamento.
- Quando o interruptor está na posição OFF, o equipamento não está desligado completamente da corrente eléctrica.
- O equipamento deve ser instalado perto da fonte de alimentação para que a mesma seja de fácil acesso.
- Não toque em focos de luz durante e imediatamente a seguir à sua utilização.
- Durante e imediatamente a seguir à sua utilização, este equipamento fica quente em determinadas áreas com excepção aos controlos e às conexões do painel traseiro. Não toque em pontos quentes especialmente no topo do painel. O contacto com áreas quentes pode causar queimaduras.

Svenska

VARNINGAR

- Utsätt inte utrustningen för regn eller fukt.
- Ta inte bort utrustningens hölje.
- För inte in föremål i utrustningen genom ventilationshålen.
- Hantera inte nätsladden med våta händer.
- Täck inte för ventilationsöppningarna med några föremål som till exempel bordsdukar, dagstidningar, gardiner e.d.
- Inga föremål med öppen låga, som till exempel tända stearinljus, bör placeras på utrustningen.
- Följ de lagar och miljöskyddsråd som gäller i det land eller område där du bor när du gör dig av med batterier.

- Se till att det finns omkring 0,2 meter fri plats runt omkring enheten.
- Inga objekt som är fyllda med någon vätska, till exempel blomstervaser, bör placeras på apparaten.
- Även om strömbrytaren står i det avstängda läget OFF, så är utrustningen inte helt bortkopplad från det elektriska nätet (MAINS).
- Utrustningen ska vara installerad nära strömuttaget så att strömförsörjningen är lätt att tillgå.
- Vidrör inte varma punkter under och omedelbart efter användning.
- Bortsett från kontrollerna och anslutningsuttagen på baksidan är den här produkten varm under och omedelbart efter användning. Vidrör inte varma punkter och särskilt inte ovansidan. Kontakt med varma ytor kan orsaka brännskador.

TABLE OF CONTENTS

FOREWORD	1	BASIC OPERATION (PLAYBACK)	25
EQUIPMENT MAINS WORKING SETTING.....	1	SELECTING AN INPUT SOURCE.....	25
COPYRIGHT.....	1	VIDEO CONVERT.....	25
INTRODUCTION	1	SELECTING THE SURROUND MODE.....	26
A NOTE ABOUT RECYCLING	1	ADJUSTING THE MAIN VOLUME.....	26
DESCRIPTION	2	ADJUSTING THE TONE (BASS & TREBLE) CONTROL.....	26
FEATURES	3	TEMPORARILY TURNING OFF THE SOUND.....	26
ACCESSORIES	3	USING THE SLEEP TIMER.....	26
FRONT PANEL	4	NIGHT MODE.....	26
FL DISPLAY.....	5	SURROUND MODE	27
REAR PANEL	6	OTHER FUNCTION	30
REMOTE CONTROL OPERATION	8	TV AUTO ON/OFF FUNCTION.....	30
FUNCTION AND OPERATION.....	8	ATTENUATION TO ANALOG INPUT SIGNAL.....	30
OPERATION OF REMOTE CONTROL UNIT.....	10	LISTENING THROUGH HEADPHONES.....	30
GENERAL INFORMATION OF RC-1065		VIDEO ON/OFF.....	30
TO DN-A7100.....	11	DISPLAY MODE.....	30
CONNECTIONS	12	SELECTING ANALOG AUDIO INPUT OR	
SPEAKER PLACEMENT.....	12	DIGITAL AUDIO INPUT.....	30
CONNECTING SPEAKERS.....	13	RECORDING AN ANALOG SOURCE.....	31
CONNECTING AUDIO COMPONENTS.....	14	HT-EQ (HOME THEATER EQUALIZER).....	31
CONNECTING VIDEO COMPONENTS.....	15	7.1 CH INPUT.....	31
ADVANCED CONNECTING.....	16	AUX2 INPUT.....	32
CONNECTING THE ANTENNA TERMINALS.....	17	LIP.SYNC.....	32
SETUP	19	BASIC OPERATION (TUNER)	32
ON SCREEN DISPLAY MENU SYSTEM.....	19	LISTENING TO THE TUNER.....	32
1 INPUT SETUP (ASSIGNABLE DIGITAL INPUT		PRESET MEMORY.....	33
AND COMPONENT VIDEO INPUT).....	20	RDS OPERATION.....	35
2 SPEAKER SETUP.....	20	TROUBLESHOOTING	36
3 PREFERENCE.....	22	RS-232C CONTROL SPECIFICATION	37
4 SURROUND.....	22	GLOBAL DESCRIPTION.....	37
5 PL II (PRO LOGIC II) MUSIC PARAMETER.....	23	DETAILED DESCRIPTION.....	37
6 CS II (CIRCLE SURROUND II) PARAMETER.....	23	RECOMMENDATIONS OF COMMAND,	
7 7.1 CH INPUT LEVEL.....	23	STATUS AND LAYER DEFINITION.....	39
SIMPLE SETUP	24	RECOMMENDATIONS OF COMMAND,	
		STATUS AND LAYER.....	40
		TECHNICAL SPECIFICATIONS	43
		DIMENSIONS	43

FOREWORD

This section must be read before any connection is made to the mains supply.

EQUIPMENT MAINS WORKING SETTING

Your DENON product has been prepared to comply with the household power and safety requirements that exist in your area.
DN-A7100 can be powered by 230V AC only.

COPYRIGHT

Recording and playback of any material may require consent. For further information refer to the following:

- Copyright Act 1956
- Dramatic and Musical Performers Act 1958
- Performers Protection Acts 1963 and 1972
- Any subsequent statutory enactments and orders

CAUTIONS ON INSTALLATION

For heat dispersal, leave at least 0.2 m/8 inch of space between the top, back and sides of this unit and the wall or other components.

- Do not obstruct the ventilation holes.

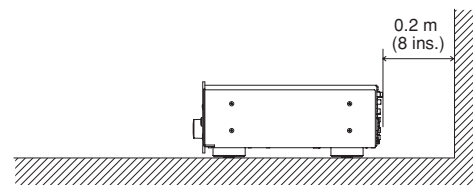
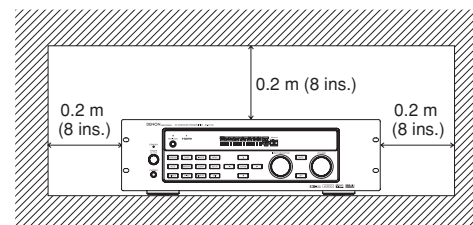

INTRODUCTION

Thank you for purchasing the DENON DN-A7100 Surround receiver.

This remarkable component has been engineered to provide you with many years of home theater enjoyment. Please take a few minutes to read this manual thoroughly before you connect and operate the DN-A7100.

As there are a number of connection and configuration options, you are encouraged to discuss your own particular home theater setup with your DENON A/V specialist dealer.

A NOTE ABOUT RECYCLING



This product's packaging materials are recyclable and can be reused. This product and the accessories packed together are the applicable product to the WEEE directive except batteries.

Please dispose of any materials in accordance with your local recycling regulations. When discarding the unit, comply with your local rules or regulations.

Batteries should never be thrown away or incinerated but disposed of in accordance with your local regulations concerning chemical wastes.

DESCRIPTION

DIGITAL
DTS
SURROUND

DTS was introduced in 1994 to provide 5.1 channels of discrete digital audio into home theater systems.

DTS brings you premium quality discrete multichannel digital sound to both movies and music.

DTS is a multichannel sound system designed to create full range digital sound reproduction.

The no compromise DTS digital process sets the standard of quality for cinema sound by delivering an exact copy of the studio master recordings to neighborhood and home theaters.

Now, every moviegoer can hear the sound exactly as the moviemaker intended.

DTS can be enjoyed in the home for either movies or music on of DVD's, LD's, and CD's.

"DTS" and "DTS Digital Surround" are registered trademarks of Digital Theater Systems, Inc.

DTS NEO:6

The advantages of discrete multichannel systems over matrix are well known.

But even in homes equipped for discrete multichannel, there remains a need for high-quality matrix decoding. This is because of the large library of matrix surround motion pictures available on disc and on VHS tape; and analog television broadcasts.

The typical matrix decoder of today derives a center channel and a mono surround channel from two-channel matrix stereo material. It is better than a simple matrix in that it includes steering logic to improve separation, but because of its mono, band-limited surround it can be disappointing to users accustomed to discrete multichannel.

Neo:6 offers several important improvements as follow,

- Neo:6 provides up to six full-band channels of matrix decoding from stereo matrix material. Users with 6.1 and 5.1 systems will derive six and five separate channels, respectively, corresponding to the standard home-theater speaker layouts.
- Neo:6 technology allows various sound elements within a channel or channels to be steered separately, and in a way which follows naturally from the original presentation.
- Neo:6 offers a music mode to expand stereo nonmatrix recordings into the five- or six-channel layout, in a way which does not diminish the subtlety and integrity of the original stereo recording.

EXTENDED
DTS ES
SURROUND

DTS-ES Extended Surround is a new multichannel digital signal format developed by Digital Theater Systems Inc. While offering high compatibility with the conventional DTS Digital Surround format, DTS-ES Extended Surround greatly improves the 360-degree surround impression and space expression thanks to further expanded surround signals. This format has been used professionally in movie theaters since 1999.

In addition to the 5.1 surround channels (FL, FR, C, SL, SR and LFE), DTS-ES Extended Surround also offers the SB (Surround Back) channel for surround playback with a total of 6.1 channels. DTS-ES Extended Surround includes two signal formats with different surround signal recording methods, as DTS-ES Discrete 6.1 and DTS-ES Matrix 6.1.

"DTS", "DTS-ES" and "Neo:6" are trademarks of Digital Theater Systems, Inc.

DTS 96/24

The stereo CD is a 16-bit medium with sampling at 44.1 kHz. Professional audio has been 20- or 24-bit for some time, and there is increasing interest in higher sampling rates both for recording and for delivery into the home. Greater bit depths provide extended dynamic range. Higher sampling rates allow wider frequency response and the use of anti-alias and reconstruction filters with more favorable aural characteristics.

DTS 96/24 allows for 5.1 channel sound tracks to be encoded at a rate of 96kHz/24bits on DVD-Video titles.

When DVD-video appeared, it became possible to deliver 24-bit, 96 kHz audio into the home, but only in two channels, and with serious limitations on picture. This capability has had little use.

DVD-audio allows 96/24 in six channels, but a new player is needed, and only analog outputs are provided, necessitating the use of the D/A converters and analog electronics provided in the player.

DTS 96/24 offers the following:

1. Sound quality transparent to the original 96/24 master.
2. Full backward compatibility with all existing decoders. (Existing decoders will output a 48 kHz signal)

3. No new player required: DTS 96/24 can be carried on DVD-video, or in the video zone of DVD-audio, accessible to all DVD players.

4. 96/24 5.1-channel sound with full-quality full-motion video, for music programs and motion picture soundtracks on DVD-video.

"DTS" and "DTS 96/24" are trademarks of Digital Theater Systems, Inc.

DOLBY
DIGITAL EX
PRO LOGIC IIX

Dolby Digital identifies the use of Dolby Digital audio coding for such consumer formats as DVD and DTV. As with film sound, Dolby Digital can provide up to five full-range channels for left, center, and right screen channels, independent left and right surround channels, and a sixth (".1") channel for low-frequency effects.

Dolby Surround Pro Logic II is an improved matrix decoding technology that provides better spatiality and directionality on Dolby Surround program material; provides a convincing three-dimensional soundfield on conventional stereo music recordings; and is ideally suited to bring the surround experience to automotive sound. While conventional surround programming is fully compatible with Dolby Surround Pro Logic II decoders, soundtracks will be able to be encoded specifically to take full advantage of Pro Logic II playback, including separate left and right surround channels. (Such material is also compatible with conventional Pro Logic decoders.)

Dolby Digital EX creates six full-bandwidth output channels from 5.1-channel sources. This is done using a matrix decoder that derives three surround channels from the two in the original recording. For best results, Dolby Digital EX should be used with movies soundtracks recorded with Dolby Digital Surround EX.

About Dolby Pro Logic IIX

Dolby Pro Logic IIX technology delivers a natural and immersing 7.1-channel listening experience to the home theater environment. A product of Dolby's expertise in surround sound and matrix decoding technologies, Dolby Pro Logic IIX is a complete surround sound solution that maximizes the entertainment experience from stereo as well as 5.1-channel encoded sources.

Dolby Pro Logic IIX is fully compatible with Dolby Surround Pro Logic technology and can optimally decode the thousands of commercially available Dolby Surround encoded video cassettes and television programs with enhanced depth and spatiality. It can also process any high-quality stereo or Advanced Resolution 5.1-channel music content into a seamless 6.1- or 7.1-channel listening experience.

Manufactured under license from Dolby Laboratories. "Dolby", "Pro Logic", and the double-D symbol are trademarks of Dolby Laboratories.

SRS
Circle Surround II

Circle Surround II (CS-II) is a powerful and versatile multichannel technology. CS-II is designed to enable up to 6.1 multichannel surround sound playback from mono, stereo, CS encoded sources and other matrix encoded sources. In all cases the decoder extends it into 6 channels of surround audio and a LFE/subwoofer signal. The CS-II decoder creates a listening environment that places the listener "inside" music performances and dramatically improves both hi-fi audio conventional surround-encoded video material. CS-II provides composite stereo rear channels to greatly improve separation and image positioning – adding a heightened sense of realism to both audio and A/V productions.

CS-II is packed with other useful feature like dialog clarity (SRS Dialog) for movies and cinema-like bass enrichment (TruBass). CS-II can enable the dialog to become clearer and more discernable in movies and it enables the bass frequencies contained in the original programming to more closely achieve low frequencies – overcoming the low frequency limitations of the speakers by full octave.

Circle Surround II, Dialog Clarity, TruBass, SRS and  symbol are trademarks of SRS Labs, Inc. Circle Surround II, Dialog Clarity and TruBass technology are incorporated under license from SRS Labs, Inc.



HDCD® (High Definition Compatible Digital®) is a patented process for delivering on Compact Disc the full richness and details of the original microphone feed.

HDCD encoded CDs sound better because they are encoded with 20-bits of real musical information as compared to 16-bits for all other CDs.

HDCD overcomes the limitation of the 16-bit CD format by using a sophisticated system to encode the additional four bits onto the CD while remaining completely compatible with the CD format.

When listening to HDCD recordings, you hear more dynamic range, a focused 3-D sound stage, and extremely natural vocal and musical timbre. With HDCD, you get the body, depth and emotion of the original performance not a flat, digital imitation.

HDCD system manufactured under license from Microsoft. This product is covered by one or more of the following: In the United States 5,479,168 5,638,074 5,640,161 5,808,574 5,838,274 5,854,600 5,864,311 5,872,531 and in Australia 669,114 with other patents pending.

HDMI

HDMI, the **HDMI** and High-Definition Multimedia Interface are trademarks or registered trademarks of HDMI Licensing LLC.

FEATURES

The DN-A7100 incorporates the latest generation of digital surround sound decoding technology such as Dolby Digital EX, Dolby Digital, DTS-ES (Discrete 6.1 and Matrix 6.1), DTS Neo:6 (Cinema, Music), Dolby Pro-Logic IIx (Movie, Music and Game), Circle Surround II (Cinema and Music).

In addition, DENON has focused on the future. By utilizing pre-out jacks, 7.1 direct inputs and a RS-232C communication port, the DN-A7100 is tomorrow's technology, today!

The DN-A7100 incorporates the most advanced Digital Signal Processing circuitry, along with a Crystal® 192 kHz/24 bit D/A converter in each of the 7 channels. Independent power supply circuits are incorporated for the FL display, audio and video sections for maximum separation, clarity and dynamic range. Together with hand-selected customized components, all elements work in harmony to recreate the emotion, exactly as the artist had intended.

The DN-A7100 is designed and engineered with extensive feedback from custom installation experts, dealers and consumers. It features multisource, a RS-232C communication port and an extensive array of both analog and digital inputs / outputs. With 6 assignable digital inputs (including Front Aux), 3 assignable component inputs, SACD Multi Channel (7.1 channel) direct inputs video convert system and OSD output versatility is taken to a stunning new level. Furthermore, the DN-A7100 can output the OSD information through the Y/C (S-video) and composite video outputs.

An easy-to-use universal remote control allows full access to all of the operating functions.

This unit has Simple Setup function for easy setup. You can setup all speaker settings by just selecting your room size and the number of your speakers with Simple Setup function. You can also setup customized settings just like conventional AV amplifiers.

- Dolby Digital EX, Dolby Digital , DTS ES (Discrete 6.1, Matrix 6.1, Neo: 6)
- Dolby Pro Logic IIx (Movie, Music, Game)
- Circle Surround II (Movie, Music, Mono)
- HDCD decoding
- 192 kHz/24 bit Crystal® DAC for all 8 Channels
- 32 bit Digital Surround Processing Chipsets
- Video Off Mode
- RS-232C Terminal for System Control
- Set Up Menu via all Video Output (Composite, S-Video and Component video)
- Auto Input Signal Detection
- Improved Station Name Input Method, 50 Presets
- Auto Adjust Function for Speaker Distance Settings (Delay Time)
- XLR type Balanced Audio Input (AUX Input)
- Remote control
- Simple Setup Function
- Video convert system
- LIP.SYNC Function (Audio delay)
- XLR type Balanced Audio Output

ACCESSORIES

Remote Controller RC-1065

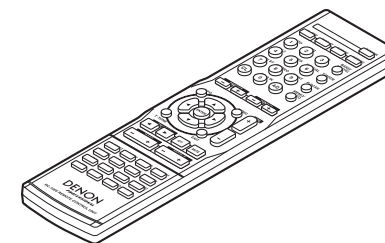

AAA-size batteries × 2

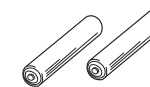

AM Loop Antenna

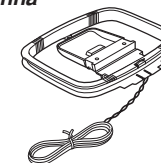

FM Antenna

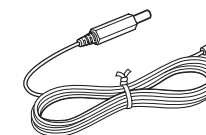

AC Power Cord

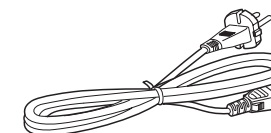

User Guide

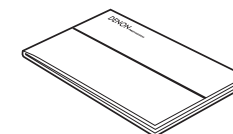

Service Station List × 1

FRONT PANEL

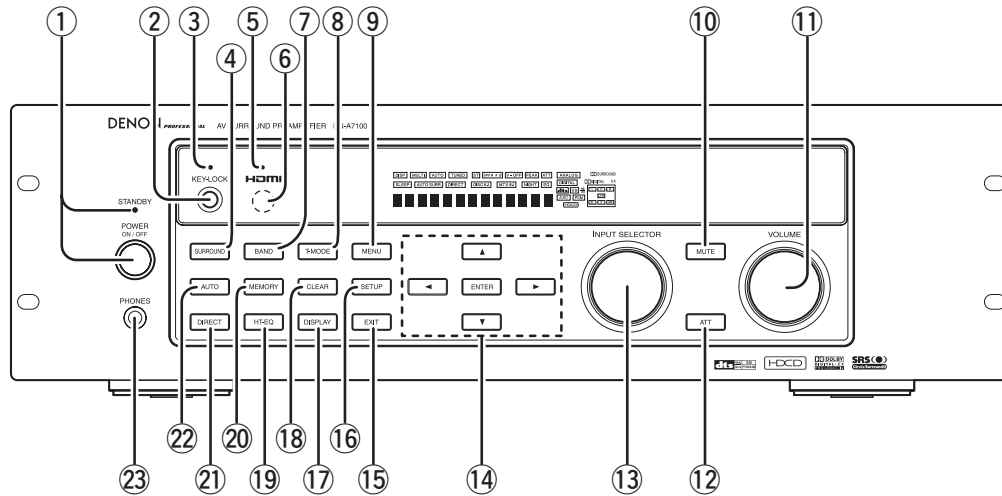

① POWER switch and STANDBY indicator

Press the button to turn the power ON, and press again to turn it OFF. If the **POWER** switch is in the ON position, the power of this unit can be turned ON/OFF by pressing the **POWER** button on the remote control unit.

When this unit is in the standby mode with the **POWER** switch set to the ON position, pressing the **ENTER** button also allows to turn the power on.

The **STANDBY** indicator lights up when this unit is the standby mode (power OFF) by the remote control unit.

② KEY LOCK button

Press and hold this button for 3 seconds to set KEY LOCK mode. When the KEY LOCK mode is on, the unit can only be operated from the RS232C or remote control, and operation by the main unit keys is prohibited. Press and hold this button for 3 seconds to release the KEY LOCK mode.

③ KEY LOCK indicator

The indicator is illuminated when in KEY LOCK mode.

④ SURROUND MODE button

You can select the surround mode by pressing this button.

⑤ HDMI indicator

This indicator is illuminated when HDMI device is connected to the DN-A7100.

⑥ INFRARED receiving sensor window

This window receives infrared signals for the remote control.

⑦ BAND button

Press this button to switch between FM and AM in the TUNER mode.

⑧ T-MODE button

Press this button to select the auto stereo mode or mono mode when the FM band is selected. The "AUTO" indicator lights in the auto stereo mode. (See page 33)

⑨ MENU button

This button is used to enter the SETUP MAIN MANU.

⑩ MUTE button

Press this button to mute the PreAMP output. Press it again to return to the previous volume level.

⑪ VOLUME control knob

Adjusts the overall sound level. Turning the control clockwise increases the sound level.

⑫ ATT (Attenuate) button

If the selected analog audio input signal is greater than the capable level of internal processing, the PEAK indicator will illuminate. If this happens, you should press the ATT button. "ATT" is displayed when this function is activated.

The signal-input level is reduced by about half. Attenuation will not work with the output signal of "REC OUT" (TAPE, CD-R/MD and VCR output). This function is memorized for each input function.

⑬ INPUT SELECTOR knob (AUDIO/VIDEO)

This knob is used to select the input sources. The video SOURCE, such as TV, DVD, VCR1 and DSS, selects video and audio simultaneously. Audio function sources such as CD, TAPE, CDR/MD, and TUNER may be selected in conjunction with a Video source.

This feature (Sound Injection) combines a sound from one source with a picture from another. Choose the video source first, and then choose a different audio source to activate this function.

⑭ Cursor (◀, ▶, ▲, ▼) / ENTER button

Use these buttons when operating the SETUP MAIN MENU and TUNER function.

⑮ EXIT button

This button is used to exit from the SETUP MAIN MENU.

⑯ SIMPLE SETUP button

Press this button to enter the simple setup mode. You can setup the speaker conditions (speaker sizes, number of speakers, speaker delay times) quickly by pressing the cursor buttons.

⑰ DISPLAY button

When this button is pressed, the FL display mode is changed as Surround Mode → Auto-display Off → Display Off → Input Function and the display off indicator(DISP) lights up in condition of DISPLAY OFF.

⑱ CLEAR button

Press this button to cancel the station-memory setting mode or preset scan tuning. (See page 33)

⑲ HT-EQ button

Used to turn on or off HT(Home Theater)-EQ mode. This mode compensates for the audio portion of a movie sounding "bright". When this button is pressed, "EQ" indicator lights up.

⑳ MEMORY button

Press this button to enter the tuner preset memory numbers or station names. (See page 33)

㉑ PURE DIRECT button

When this button is pressed once, "SOURCE DIRECT" appears on the FL display. If pressed again, "PURE DIRECT" appears. After 2 seconds, the FL display indication goes out.

In the source/pure direct mode, the tone control circuitry and bass management are bypassed.

Notes:

- The surround mode is automatically switched to AUTO when the pure direct/source direct function is turned on.
- Additionally, speaker configurations are fixed automatically as follows.
 - Front SPKR = LARGE
 - Center SPKR = LARGE
 - Surround SPKR = LARGE
 - Surround Back SPKR = LARGE
 - Sub woofer = YES

㉒ AUTO (Auto surround) button

Press this button to select the AUTO mode from the surround modes. When this mode is selected, the receiver determines the surround mode corresponding to a digital input signal automatically.

㉓ HEADPHONE jack for stereo headphones

This jack may be used to listen to the DN-A7100's output through a pair of headphones. Be certain that the headphones have a standard 1 / 4" stereo phono plug.

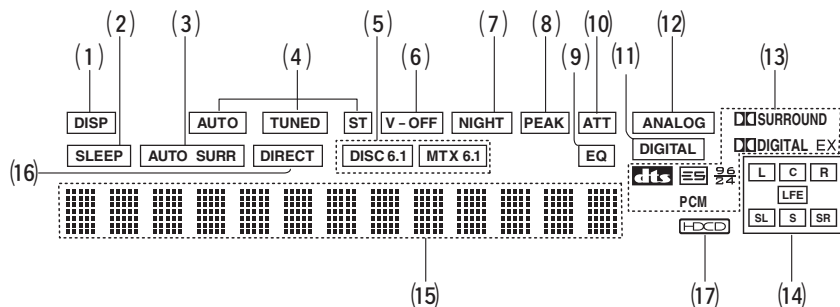

(1) DISP (Display Off) indicator

This indicator is illuminated when the DN-A7100 is in the display off condition.

(2) SLEEP timer indicator

This indicator is illuminated when the sleep timer function in the main-room is in use.

(3) AUTO SURR (Auto Surround mode) indicator

This indicator is illuminated to show that the AUTO SURROUND mode is in use.

(4) TUNER's indicators

AUTO : This indicator illuminates when the tuner's Auto mode is in use.

TUNED : This indicator illuminates when the tuner receives a sufficiently strong radio signal.

ST(Stereo) : This indicator illuminates when an FM station is being tuned into stereo condition.

(5) DTS-ES mode indicators (DISC6.1, MTX6.1)

These indicators will illuminate to show the DTS-ES decoding mode (Discrete 6.1 or Matrix 6.1).

(6) V (video)-OFF mode indicator

This indicator is illuminated when the Video-OFF function is active.

(7) NIGHT mode indicator

This indicator is illuminated when the DN-A7100 is in the Night mode, which reduces the dynamic range of digital program material at low volume levels.

(8) PEAK indicator

This indicator is a monitor for an analog audio input signal. If the selected analog audio input signal is greater than the capable level of internal processing, this will illuminate. If this happens, you should press the **ATT** button on the remote.

(9) EQ mode indicator

This indicator is illuminated when the HT-EQ function is active.

(10) ATT (Attenuation) indicator

This indicator is illuminated when the attenuation function is active.

(11) DIGITAL Input Indicator

This indicator lights when a digital input has been selected.

(12) ANALOG input indicator

This indicator is illuminated when an analog input source has been selected.

(13) SIGNAL FORMAT indicators

□ DIGITAL, EX, □ SURROUND, dts, ES, 96/24, PCM

When the selected input is a digital source, some of these indicators will be illuminated to display the specific type of signal in use.

(14) ENCODED CHANNEL STATUS indicators

These indicators display the channels that are encoded with a digital

input signal. If the selected digital input signal is Dolby Digital 5.1ch or DTS 5.1ch, "L", "C", "R", "SL", "SR" and "LFE" will be illuminated. If the digital input signal is 2 channel PCM-audio, "L" and "R" will be displayed.

If Dolby Digital 5.1ch signal with Surround EX flag or DTS-ES signal comes in, "L", "C", "R", "SL", "S", "SR" and "LFE" will be illuminated.

(15) Main Information Display

This display shows messages relating to the status, input source, surround mode, tuner, volume level or other aspects of unit's operation.

(16) DIRECT (Puredirect) indicator

This indicator is illuminated when the DN-A7100 is in the SOURCE DIRECT or PURE DIRECT mode.

(17) HDCD indicator

When HDCD signal is decoded from digital input, this indicator will light up.

REAR PANEL

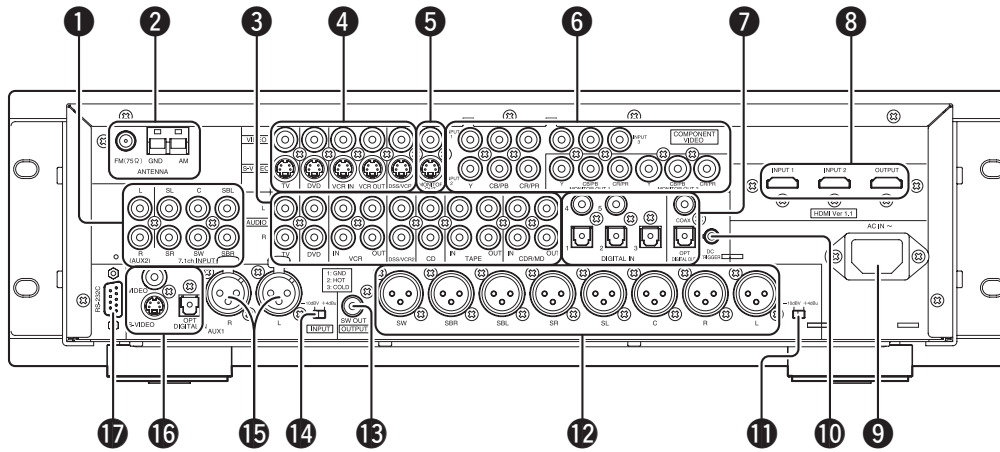

1 7.1 CHANNEL or AUX2 INPUT

By connecting a DVD Audio player, SACD multichannel player, or other components that has a multichannel port, you can playback the audio with 5.1 channel or 7.1 channel outputs.

2 FM antenna terminal (75 ohms)

Connect an external FM antenna with a coaxial cable, or a cable network FM source.

AM antenna and ground terminals

Connect the supplied AM loop antenna. Use the terminals marked "AM" and "GND". The supplied AM loop antenna will provide good AM reception in most areas. Position the loop antenna until you hear the best reception.

3 AUDIO IN/OUT (CD, TAPE, CD-R/MD, TV, DVD, VCR, DSS/VCR2)

These are the analog audio inputs and outputs. There are 7 audio inputs (4 of which are linked to video inputs) and 3 audio outputs (1 of which are linked to video outputs). The audio jacks are nominally labeled for cassette tape decks, compact disc players, DVD players and etc.... The audio inputs and outputs require RCA-type connectors.

4 VIDEO IN/OUT (TV, DVD, VCR, DSS/VCR2)

These are the video inputs and outputs. There are 4 video inputs and 1 video outputs and each one includes both composite video and S-video configurations. Connect VCRs, DVD players, and other video components to the video inputs.

The video output channel can be used to be connected to video tape recorders for making recordings.

The input signals of video and S-video are converted each other, and each of the converted video signals can be output.

5 MONITOR OUT

This is a monitor output and each one includes both composite video and S-video configurations. When connecting two video monitors or televisions, be aware that the OSD interface can be used with both MONITOR OUT connections.

6 COMPONENT VIDEO INPUT/OUTPUT

If your DVD player or other device has component video connectors, be sure to connect them to these component video connectors on the DN-A7100. The DN-A7100 has two component video input connectors to obtain the color information (Y, C_B, C_R) directly from the recorded DVD signal or other video component and one component video output connector to output it directly into the matrix decoder of the display device.

By sending the pure DVD component video signal directly, the DVD signal forgoes the extra processing that normally would degrade the image. The result is vastly increased image quality, with incredibly life like colors and crisp detail.

When the video convert function is enabled, video and S-video images can be output to the COMPONENT MONITOR OUT jack.

7 DIGITAL INPUT (Dig.1-5) / OUTPUT (coaxial, optical)

These are the digital audio inputs and outputs. There are 2 digital inputs with coaxial jacks, 3 with optical jacks.

The inputs accept digital audio signals from a CD, DVD, or other digital source component.

For digital output, there is 1 coaxial output and 1 optical output.

The digital outputs can be connected to MD recorders, CD recorders, or other similar components.

8 HDMI INPUT/OUTPUT

This unit has 2 HDMI inputs and 1 HDMI output. The input function can be selected from the OSD menu system. (See page 20)

9 AC INLET

Plug the supplied power cord into this AC INLET and then into the power outlet on the wall.

DN-A7100 can be powered by 230V AC only.

10 DC TRIGGER output terminal

Connect a device that needs to be triggered by DC under certain conditions (screen, power strip, etc...) Use the system OSD setup menu to determine the conditions by which these jack will be active.

Note:

This output voltage is for (status) control only, It is not sufficient for drive capability.

11 Analog audio output level switch (-10dBV/+4dBu)

This switch changes the standard output level of the Balanced Analog audio signal.

12 Balanced Analog audio output (L, R, SL, SR, SBL, SBR, C, SW)

Balanced Analog audio output (XLR) for L (front left), R (front right), C (Center), SL (surround left), SR (surround right), SBL (surround back left), SBR (surround back right) and SW (subwoofer).

Use these jacks for connection to external power amplifiers.

13 Subwoofer Output

Connect this jack to the line level input of a powered subwoofer. If an external subwoofer amplifier is used, connect this jack to the subwoofer amplifier input. If you are using two subwoofers, either powered or with a 2 channel subwoofer amplifier, connect a "Y" connector to the subwoofer output jack and run one cable from it to each subwoofer amplifier.

14 AUX1 analog audio input level switch (-10dBV/+4dBu)

This switch changes the standard input level of the AUX1 Balanced Analog audio signal.

15 AUX1 analog audio input jacks (L/R)

These auxiliary analog audio input jacks accept the connections with analog audio signal output jacks (XLR jacks) of other audiovisual devices.

16 AUX1 VIDEO / DIGITAL AUDIO INPUT

These auxiliary video/audio input jacks accept the connections of a camcorder, portable DVD etc.

17 RS-232C

The RS-232C port is to be used in conjunction with an external controller to control the operation of the DN-A7100 by using an external device.

REMOTE CONTROL OPERATION

FUNCTION AND OPERATION

Used to remotely control the unit. You can switch between functions by pressing either the **AMP** or **TUNER** source buttons.

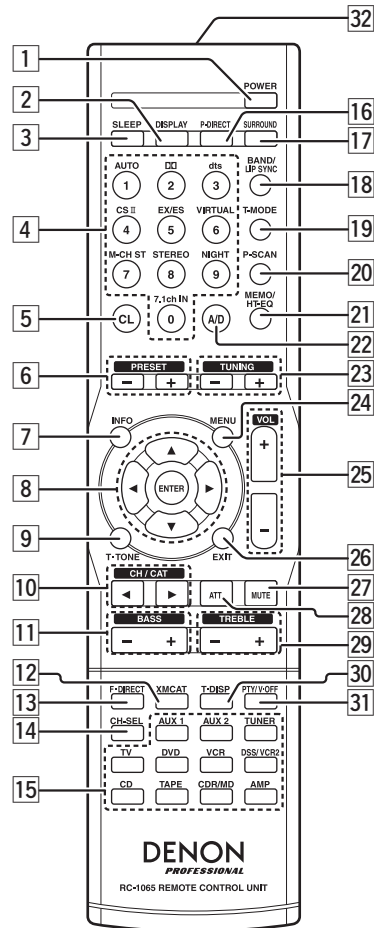

1 POWER buttons

This buttons is used to turn the DN-A7100 on or off.

2 DISPLAY button

Selects the display mode for the front display of the DN-A7100.

3 SLEEP button

This button is used for setting the sleep timer.

4 Numeric buttons

These buttons are used to switch between 0 to 9 of the source components.

If the source is set to the AMP (amplifier), these buttons are used to perform operations.

(When AMP mode is selected)

1/AUTO button

Used to select auto surround.

2/Dolby button

Used to select DOLBY mode.

3/dts button

Used to select dts mode.

4/CSII button

Used to select CSII mode.

5/EX/ES button

Used to select EX/ES mode.

6/VIRTUAL button

Used to select VIRTUAL mode.

7/M-CH ST button

Used to select Multi Channel Stereo.

8/STEREO button

Used to select STEREO mode.

9/NIGHT button

Pressing this button prevents the Dolby Digital signal from playback at a loud voice. This function reduces the voice by 1/3 to 1/4 at maximum. Thus, it eliminates the occurrence of an abruptly loud voice at night. However, the function is valid only in the case when the Dolby Digital signal is entered into OPTICAL or COAXIAL and data to compress the voice exists in the signal to be played back. When this button is pressed, the "NIGHT" indicator is illuminated.

0/7.1CH IN button

Press this button to select the output of an external multi channel decoder.

5 CL (Clear) button

(When TUNER mode is selected)

This button is used to erase the memory or program of a source.

6 PRESET +/- buttons

(When TUNER mode is selected)

Used to select a preset station up and down.

7 INFO button

(When AMP mode is selected)

When this button is pressed, the current setting are displayed on the TV monitor.

8 ◀, ▶, ▲, ▼ (CURSOR) / ENTER buttons

(When AMP mode is selected)

These buttons are used when controlling the cursor of the DN-A7100.

9 T.TONE button

(When AMP mode is selected)

Used to enter the test tone menu.

10 CH/CAT▲ (UP) / ▼ (DOWN) buttons

(When TUNER mode is selected)

These buttons are used to change channels.

Not used on this unit.

11 BASS +/- buttons

These buttons are used to adjust the tone control of low frequency sound for left, right and subwoofer speaker.

12 XMCAT button

(When TUNER mode is selected)

Press this button is used to select the XM Category mode.

Not used on this unit.

13 F.DIRECT button

(When TUNER mode is selected)

Used to select the "Frequency direct input".

14 CH. SEL button

(When TUNER mode is selected)

Used to call up SETUP MAIN MENU and adjust speaker levels or 7.1 ch input level.

15 SOURCE button

These buttons are used to switch the source of your A/V Receiver / amplifier. Each time a source button is pressed, the remote control changes to the source which was pressed.

Note:

Select the AMP as the source to use this remote controll with the DN-A7100.

16 P.DIRECT button

When this button is pressed, the tone control circuit is bypassed.

17 SURROUND button

This button is used to selects the surround mode.

18 BAND/LIP SYNC button

(When TUNER mode is selected)

Used to select a radio band.

(When AMP mode is selected)

Used to select LIP SYNC mode.

19 T-MODE button

(When TUNER mode is selected)

Used to select auto stereo mode or mono mode when the FM band is selected. The "AUTO" indicator lights in the auto stereo mode.

20 P-SCAN button

(When TUNER mode is selected)

Used to start preset scan.

21 MEMO/HT-EQ button

(When TUNER mode is selected)

This button is used to store setting to memory or program a source.

(When AMP mode is selected)

Used to turn on or off HT(Home Theater)-EQ mode. This mode compensates for the audio portion of a movie sounding "bright".

When this button is pressed, "EQ" indicator light up.

22 A/D button

(When AMP mode is selected)

Used to switch between the analog and digital inputs.

23 TUNING +/- buttons

(When TUNER mode is selected)

Used to tune a frequency station up and down.

24 MENU button

(When AMP mode is selected)

This button is used to call up the SETUP MAIN MENU of the DN-A7100.

25 VOLUME +/- buttons

This button is used to adjust the volume for the amplifier.

26 EXIT button

(When AMP mode is selected)

This button is used to cancel setting in the setup menu.

27 MUTE button

This button is used to mute the audio for the amplifier.

28 ATT button

(When AMP mode is selected)

When the input signal is too high and the voice distorts even by throttling the DN-A7100 VOLUME control, turn on this function.

"ATT" is indicated when this function is activated.

The input level reduced. Attenuator is invalid for the output signal of "REC OUT".

Note:

This function is unavailable while the digital input is selected.

29 TREBLE +/- buttons

These buttons are used to adjust the tone control of high frequency sound for left and right speaker.

30 T-DISP button

(When TUNER mode is selected)

Used to select the display mode in RDS.

31 PTY/V-OFF button

(When TUNER mode is selected)

Used to display the programme type information of the current station.

(When AMP mode is selected)

Used to turn off the video signal.

32 Infrared Transmitter

This transmitter emits infrared light. Press the buttons while pointing the transmitter towards the infrared receiver window of the DN-A7100.

OPERATION OF REMOTE CONTROL UNIT

REMOTE CONTROL

The distance between the transmitter of the remote control and the IR SENSOR of the DN-A7100 should be less than 5 meters. If the remote control is pointed in a direction other than the IR SENSOR or if there is an obstacle between them, use of the remote control may not be possible.

Remote-controllable range

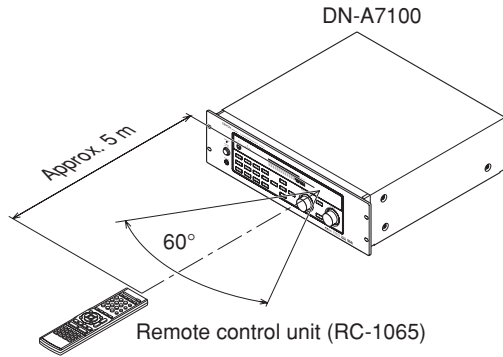

LOADING BATTERIES

The life of the batteries used with the remote control is about 4 months with normal use. Also be sure to replace batteries earlier when you notice that they are getting weak.

1. Remove the back cover.

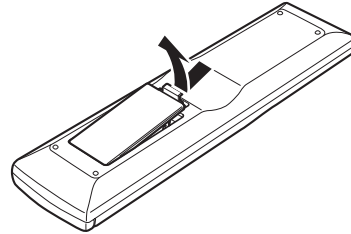

2. Insert the new batteries (AAA type) with correct \oplus and \ominus polarity.

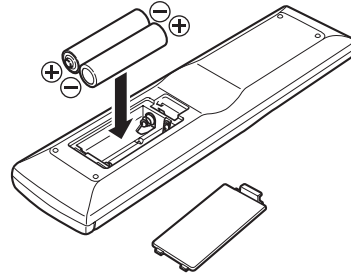

3. Close the cover until it clicks.

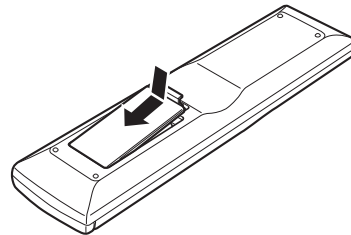

Notes:

- Do not mix alkaline and manganese batteries.
- Do not mix old and new batteries.

CAUTIONS ON BATTERIES

- Use “AAA” type batteries in this remote control unit.
- We recommend that you use alkali batteries.
- If the remote control unit does not operate from close to the main unit, replace the batteries with new ones, even if less than a year has passed.
- The included battery is only for verifying operation. Replace it with a new battery as soon as possible.
- When inserting the batteries, be careful to do so in the proper direction, following the + and - marks in the remote control unit's battery compartment.
- To prevent damage or battery fluid leakage:
 - Do not use a new battery with an old one.
 - Do not use two different types of batteries.
 - Do not short-circuit, disassemble, heat or dispose of batteries in flames.
- Remove the batteries when not planning to use the remote control unit for a long period of time.
- If the batteries should leak, carefully wipe off the fluid from the inside of the battery compartment, then insert new batteries.
- When disposing of used batteries, please comply with governmental regulations or environmental public instruction's rules that apply in your country or area.

GENERAL INFORMATION OF RC-1065 TO DN-A7100

To control the DN-A7100 by your RC-1065, you have to select the device AMP or TUNER by pressing the **SOURCE** button. Please refer below for the details in AMP and TUNER mode.

AMP MODE



POWER	Turns the DN-A7100 on and off
SLEEP	Sets the sleep timer function
DISPLAY	Changes the front display mode
P-DIRECT	Selects the pure direct mode
SURROUND	Selects the surround mode
AUTO (1)	Selects auto surround
DOLBY (2)	Selects DOLBY mode
dts (3)	Selects dts mode
BAND/LIP SYNC	Select LIP SYNC mode
CSII (4)	Selects CS2 mode
EX/ES (5)	Selects EX/ES
VIRTUAL (6)	Selects VIRTUAL mode
M-CH ST (7)	Selects the Multi Channel Stereo
STEREO (8)	Selects STEREO mode
NIGHT (9)	Turns on or off NIGHT mode
7.1ch IN (0)	Selects the 7.1ch input ports
A/D	Switches between the analog or digital inputs
MEMO/HT-EQ	Turns on or off HT-EQ mode
INFO	Turns on or off the "On Screen Display"
MENU	Display the current setting on the monitor
CURSOR ◀/▶/▲/▼	Moves the cursor for setting in "On Screen Display"
ENTER	Enters the "On Screen Display"
	Confirms the setting in "On Screen Display"
T-TONE	Enters the test tone menu
EXIT	Exits from SETUP MENU
VOL+	Adjusts up to the over all sound level
VOL-	Adjusts down to the over all sound level
ATT	Reduces the analog input level
MUTE	Decreases the sound temporarily
BASS-	Adjusts down to the tone control of low frequency sound
BASS+	Adjusts up to the tone control of low frequency sound
TREBLE-	Adjusts down to the tone control of high frequency sound
TREBLE+	Adjusts up to the tone control of high frequency sound
PTY/V-OFF	Turns on or off Video output
CH-SEL	Calls up SETUP MENU and adjusts speaker level or 7.1ch input level
AUX1	Input source select AUX1
AUX2	Input source select AUX2
TUNER	Input source select TUNER
TV	Input source select TV
DVD	Input source select DVD
VCR	Input source select VCR
DSS/VCR2	Input source select DSS/VCR2
CD	Input source select CD
TAPE	Input source select TAPE
CDR/MD	Input source select CDR/MD

TUNER MODE

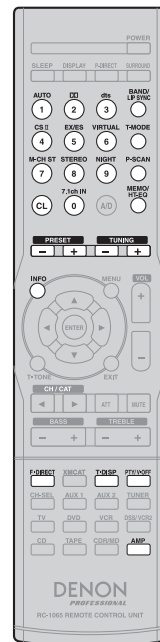

0-9	Inputs the numeric
BAND/LIP SYNC	Select a radio band
T-MODE	Selects the auto stereo mode or mono mode
P-SCAN	Starts preset scan
CL	Clears the input data
MEMO/HT-EQ	Enters the tuner preset memory numbers
PRESET-	Selects a preset station down
PRESET+	Selects a preset station up
TUNING-	Tunes a frequency station down
TUNING+	Tunes a frequency station up
INFO	Shows preset information
F-DIRECT	Selects the "Frequency direct input"
T-DISP	Selects the display mode in RDS
PTY/V-OFF	Turns PTY group or type search mode on or off
AMP	Select AMP mode

* POWER, SLEEP, DISPLAY, P-DIRECT, SURROUND, VOL+, VOL-, MUTE, BASS+, BASS-, TREBLE+, and TREBLE- keys can be selected in TUNER mode the same as in AMP mode.

CONNECTIONS

SPEAKER PLACEMENT

The ideal surround speaker system for this unit is 7-speaker systems, using front left and right speakers, a center speaker, surround left and right speakers, a surround back left and right speakers, and a subwoofer.

For best results we recommend that all front speakers be of the same type, with identical or similar driver units. This will deliver smooth pans across the front sound stage as the action moves from side to side. Your center channel speaker is very important as over 80% of the dialog from a typical motion picture emanates from the center channel.

It should possess similar sonic characteristics to the main speakers. Surround channel speakers need not be identical to the front channel speakers, but they should be of high quality.

The surround back speaker is useful for playback of Dolby Digital Surround EX or DTS-ES. One of the benefits of both Dolby Digital and DTS is that surround channels are discrete full range, while they were frequency limited in earlier "Pro Logic" type systems.

Bass effects are an important part of home theater. For optimal enjoyment a subwoofer should be used as it is optimized for low frequency reproduction. If you have full range front speakers, however, they may be used in place of a subwoofer with proper setting of the switches in the menu system.

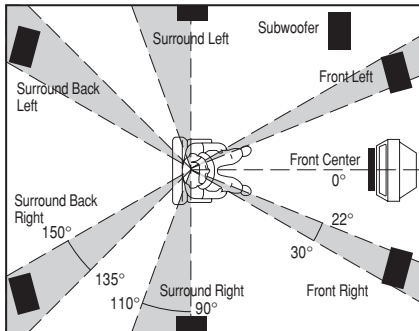

Front left and right speakers

We recommend to set the front L and R speakers with 45-60 degrees from the listening position.

Center speaker

Align the front line of the center speaker with the front L/R speakers. Or place the center speaker a little backward from the line.

Surround left and right speakers

When the DN-A7100 is used in surround operation, the preferred location for surround speakers is on the side walls of the room, at or slightly behind the listening position.

The center of the speaker should face into the room.

Surround back left and right speakers

Surround back speakers are required when a full 7.1-channel system is installed.

Speakers should be placed on a rear wall, behind the listening position.

The center of the speaker should face into the room.

Subwoofer

We recommend using a sub-woofer to have maximum bass effect. As the subwoofer only handles low frequencies, its placement is not of particular importance when used indoors.

HEIGHT OF THE SPEAKER UNITS

Front left and right speakers, and a center speaker

Align the tweeters and mid-range drivers on the three front speakers at the same height, as best as possible.

Surround left and right speakers, and surround back speaker

Place the surround left, right and surround back speakers higher than your ears by about 70cm – 1m. Also place the speakers at the same height, as best as possible.

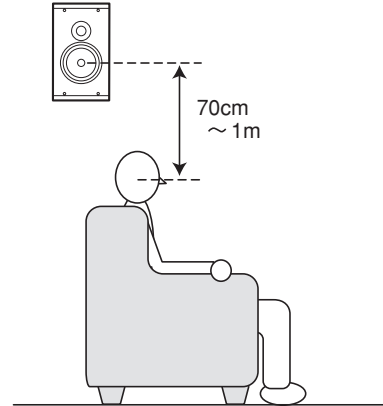

Note:

Use magnetically-shielded speakers for front left, right and the center speakers when the speakers are installed near the TV.

CONNECTING SPEAKERS

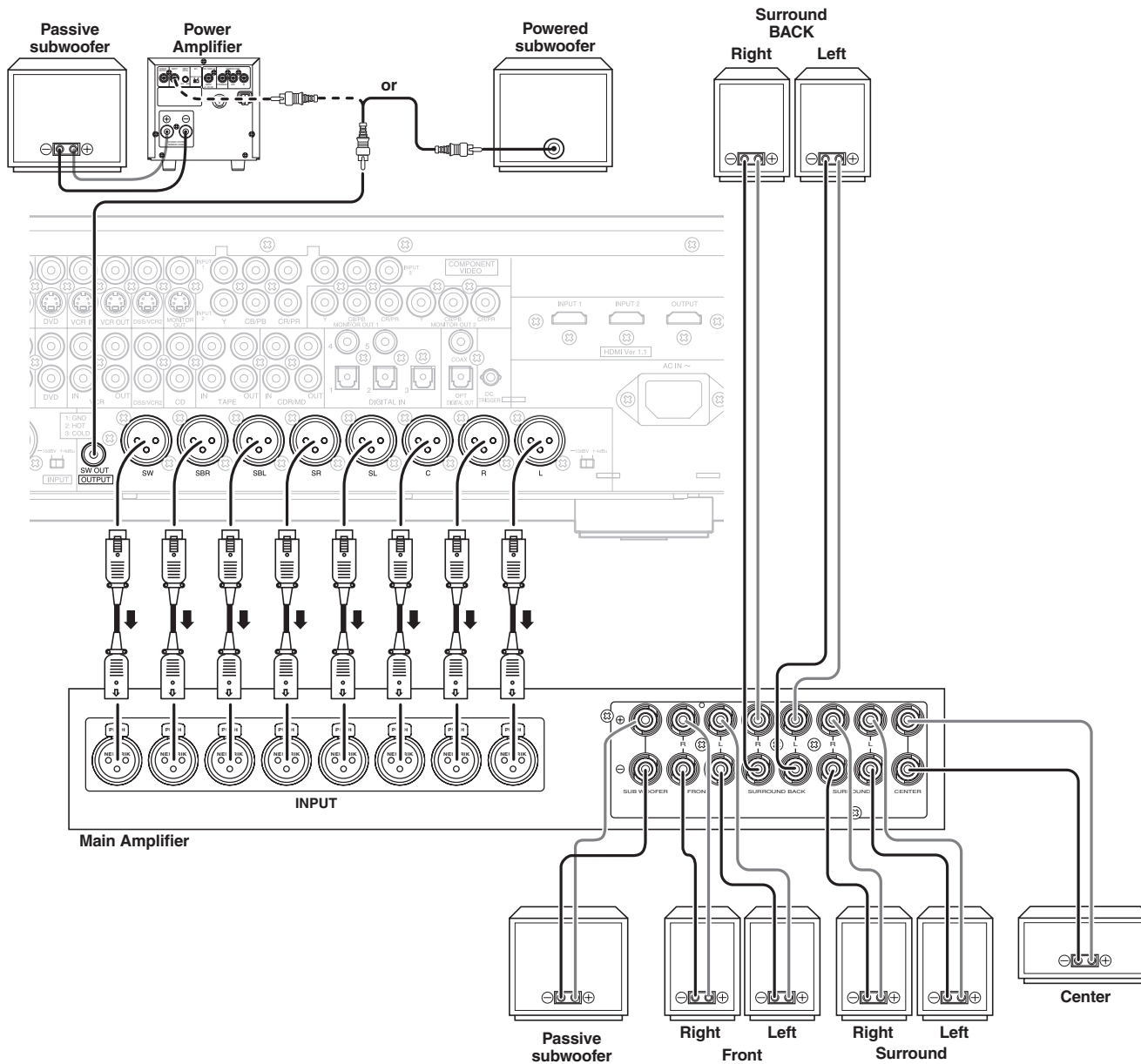

XLR terminals are used for balanced inputs and outputs.

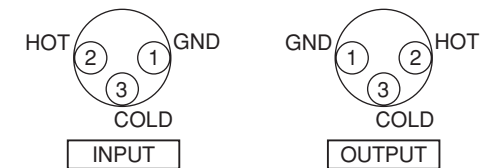

CONNECTING A SUBWOOFER

Use the SW OUT jack (RCA-type connector) to connect a powered subwoofer (power amplifier built in).

If your subwoofer is a passive type (power amplifier is not built in), connect a monaural power amplifier to the SW OUT jack (RCA-type connector) and connect the subwoofer to the amplifier.

CONNECTING AUDIO COMPONENTS

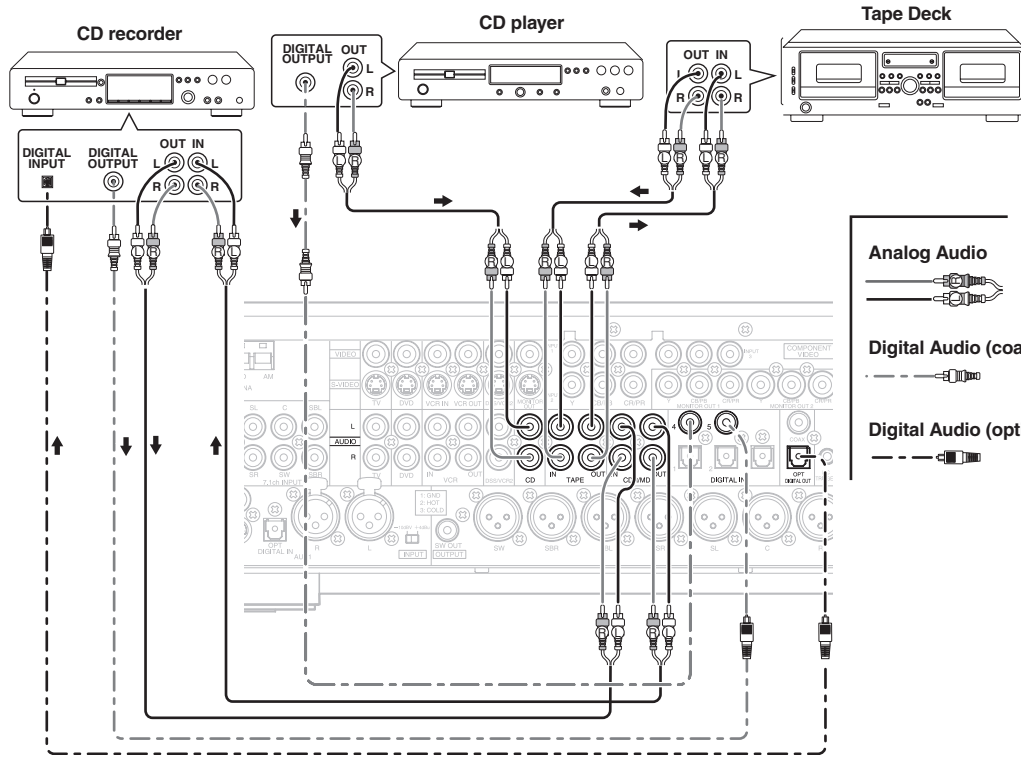

The output audio signal from the TAPE OUT jack and the CD-R/MD OUT jack is the same signal which is currently selected.

Caution:

Do not connect this unit and other components to mains power until all connections between components have been completed.

Notes:

- Insert all plugs and connectors securely. Incomplete connections may make noise.
- Be sure to connect the left and right channels properly.
Red connectors are for the R (right) channel, and white connectors are for the L (left) channel.
- Be sure to connect input and output properly.
- Refer to the instructions for each component that is connected to this unit.
- Do not bind audio/video connection cables with power cords and speaker cables this will result in generating a hum or other noise.

CONNECTING DIGITAL AUDIO COMPONENTS

- There are 6 digital inputs, 2 coaxial jacks and 4 optical jacks (include AUX), on the rear panel. You can use these jacks to input PCM, Dolby Digital and DTS bitstream signals from a CD, DVD, or other digital source components.
- There is one digital output coaxial jack and one optical output jack on the rear panel. These jacks can be connected to a CD recorder-, or a MD deck inputs, respectively.
- Refer to the instructions for each component. To setup the digital audio format of DVD player, or other digital source's connected to digital input jacks.
- Use fiber optical cables (optical) for DIG-1,2,3 or AUX1 (OPT) input jacks. Use 75 ohms coaxial cables (for digital audio or video) for DIG-4,5 input jacks.
- You can designate the input for each digital input/output jacks according to your component. See page 20.

Notes:

- There is no Dolby Digital RF input jack. Please use an external RF demodulator Dolby Digital decoder when connecting the Dolby Digital RF output jack of the video disc player to the digital input jack.
- The digital signal jacks on this unit conform to the EIA standard. If you use a cable that does not conform to this standard, this unit may not function properly.
- Each type of audio jack works independently. Signals input through the digital and analog jacks are output through the corresponding digital and analog jacks, respectively.

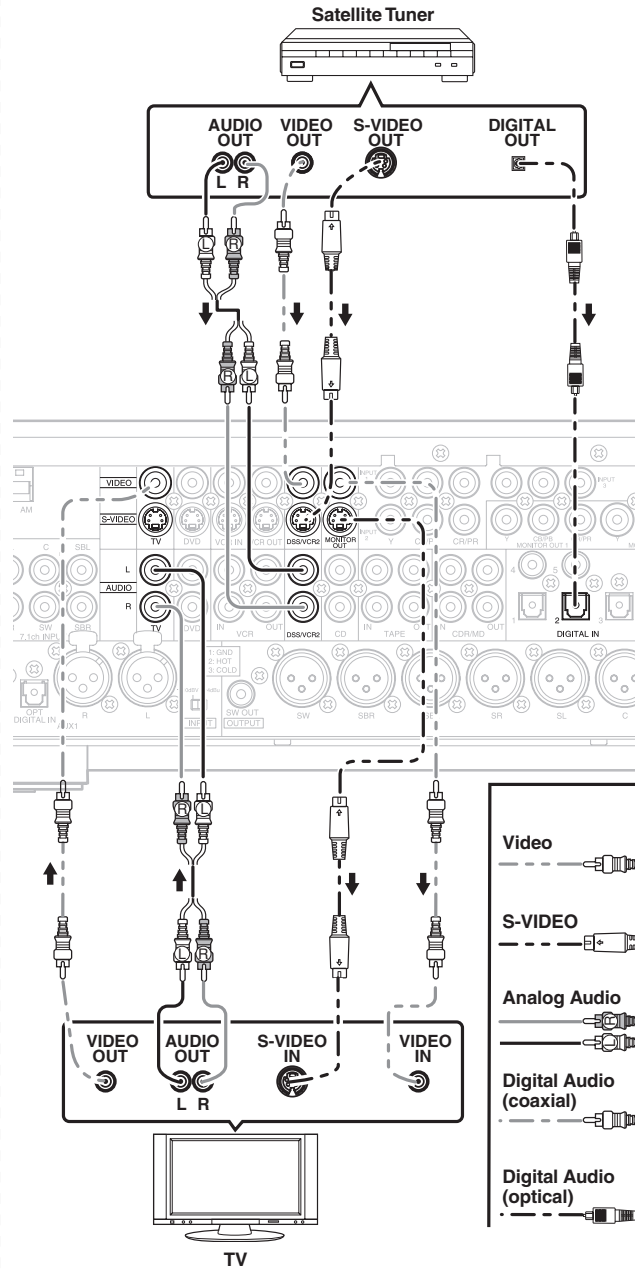
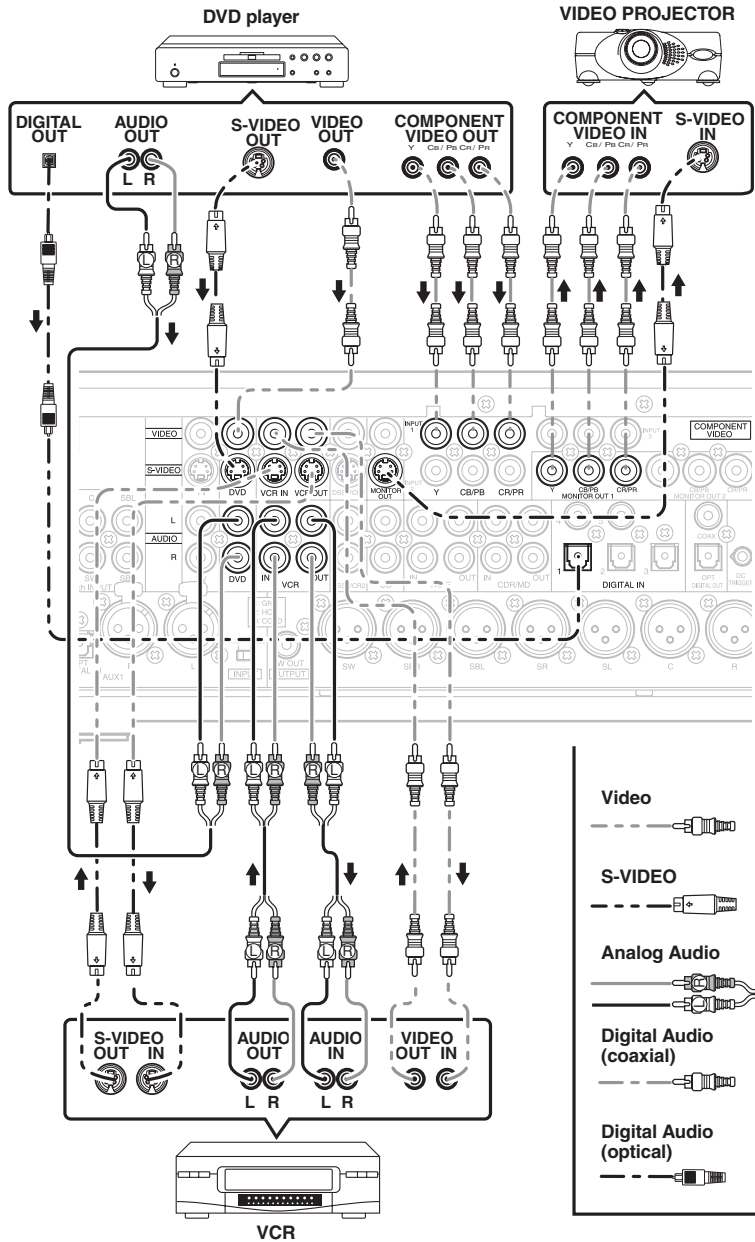

VIDEO, S-VIDEO, COMPONENT JACKS

There are 3 types of video jacks on the rear panel.

VIDEO jack

The video signal for the VIDEO jacks is the conventional composite video signal.

S-VIDEO jack

The video signal is separated into luminance (Y) and color (C) signals for the S-VIDEO jack. The S-VIDEO signals enables high-quality color reproduction. If your video component has an S-VIDEO output, we recommend to use it. Connect the S-VIDEO output jack on your video component to the S-VIDEO input jack on this unit.

Component jack

Make component video connections to a TV or monitor with component inputs to produce higher quality video images. Use a component video cable or 3 video cords to connect the component video out jacks on the DN-A7100 to the monitor.

Notes:

- Be sure to connect the left and right audio channels properly.
Red connectors are for the R (right) channel, and white connectors are the for L (left) channel.
- Be sure to connect the inputs and outputs of the video signals properly.
- If you connect the S-VIDEO or component signal to the S-VIDEO or component jack on this unit, it is not necessary to connect the conventional video signal to the VIDEO (composite) jack. If you use both video inputs, this unit gives priority to the S-VIDEO signal.
- Each type of video jack works independently. Signals input to the VIDEO (composite) and S-VIDEO jacks or component are output to the corresponding VIDEO (composite) and S-VIDEO or component jacks, respectively.
- This unit has the "TV-AUTO ON/OFF" function to turn the TV ON or OFF automatically, by sensing the incoming video signal from the VIDEO jacks.
- You may need to setup the digital audio output format of your DVD player, or other digital source components. Refer to the instructions of the each component connected to the digital input jacks.
- There is no Dolby Digital RF input jack. Please use an external RF demodulator with a Dolby Digital decoder to connect a video disc player which has a Dolby Digital RF output jack to the digital input jack on this unit.

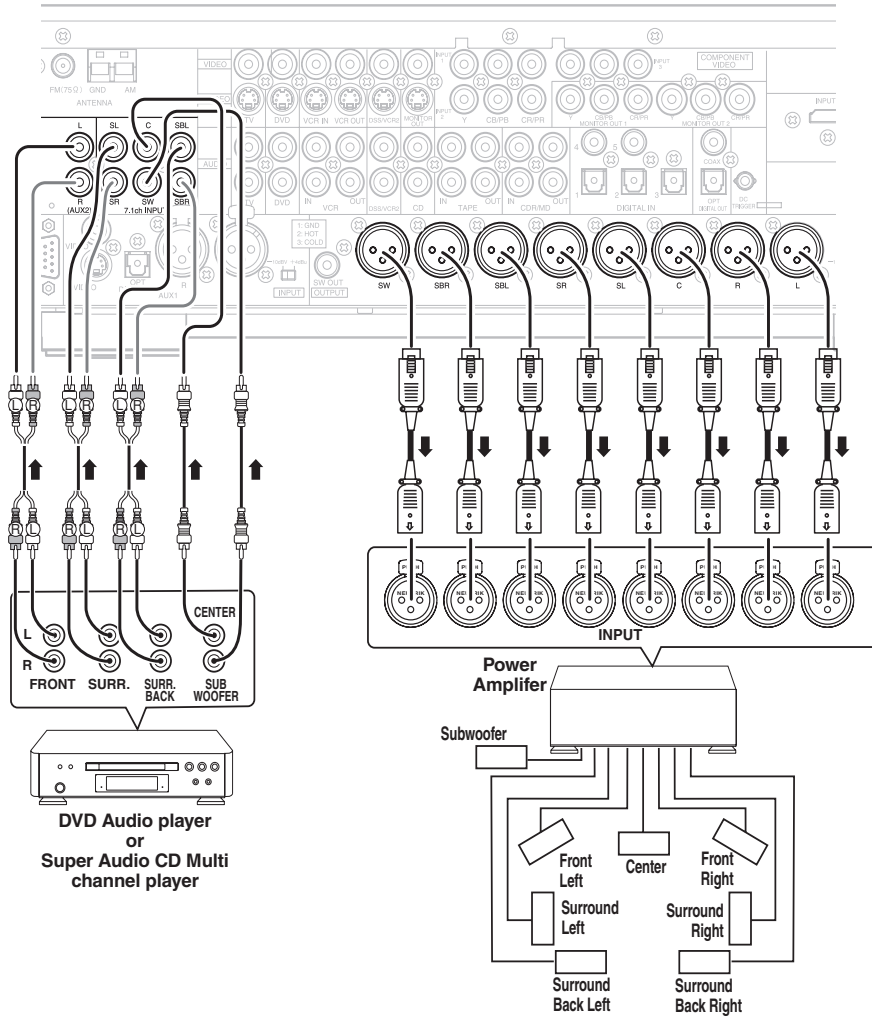

CONNECTING MULTI CHANNEL AUDIO SOURCE

The 7.1CH INPUT jacks are for multichannel audio source such as a SACD multichannel player, DVD audio player or external decoder. If you use these jacks, switch on the 7.1CH INPUT and set the 7.1CH INPUT level by using the SETUP MAIN MENU. See page 23.

CONNECTING AN EXTERNAL POWER AMPLIFIER

The PREOUT jacks are for connecting external power amplifiers. Be sure to connect each speaker to the corresponding external power amplifier.

CONNECTING THE ANTENNA TERMINALS

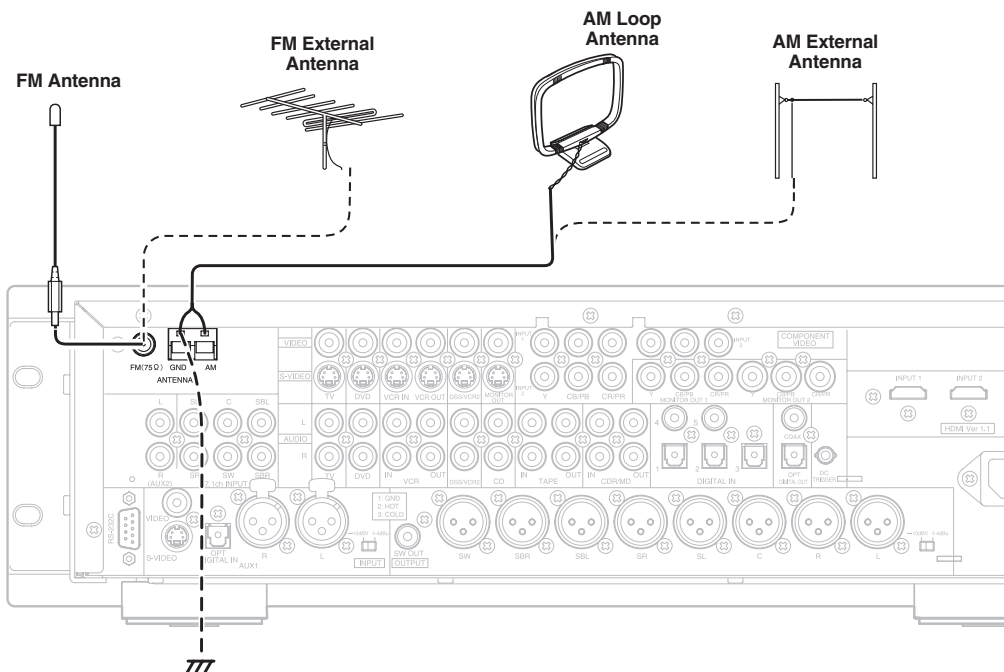

ASSEMBLING THE AM LOOP ANTENNA

1. Release the vinyl tie and take out the connection line.
4. Place the antenna on stable surface.



2. Bend the base part in the reverse direction.



3. Insert the hook at the bottom of the loop part into the slot at the base part.



CONNECTING THE SUPPLIED ANTENNAS

Connecting the supplied FM antenna

The supplied FM antenna is for indoor use only. During use, extend the antenna and move it in various directions until the clearest signal is received. Fix it with push pins or similar implements in the position that will cause the least amount of distortion. If you experience poor reception quality, an outdoor antenna may improve the quality.

Connecting the supplied AM loop antenna

The supplied AM loop antenna is for indoor use only. Set it in the direction and position it to where you receive the clearest sound. Put it as far away as possible from the unit, televisions, speaker cables, and power cords. If you experience poor reception quality, an outdoor antenna may improve the quality.

1. Press and hold down the lever of the AM antenna terminal.
2. Insert the bare wire into the antenna terminal.
3. Release the lever.

CONNECTING AN FM OUTDOOR ANTENNA

Notes:

- Keep the antenna away from noise sources (neon signs, busy roads, etc.).
- Do not put the antenna close to power lines. Keep it well away from power lines, transformers, etc.
- To avoid the risk of lightning and electrical shock, grounding is necessary.

CONNECTING AN AM OUTDOOR ANTENNA

An outdoor antenna will be more effective if it is stretched horizontally above a window or outside.

Notes:

- Do not remove the AM loop antenna.
- To avoid the risk of lightning and electrical shock, grounding is necessary.

HDMI JACK

This unit has two HDMI inputs and one HDMI output. It can send digital video and audio signals from DVDs and other sources directly to a display. It minimizes signal degradation caused by analog conversion so that high quality images can be enjoyed.

Select an input source from the OSD menu system. (See page 20)

Notes:

- When the HDMI output is connected to a display monitor that does not support HDCP, signals are not output. To view images in HDMI, it is necessary to connect to a display that supports HDCP.
- There may be no image output if connected to a TV or display that is not compatible with the above format.
- Refer to the instruction manual of the TV or display to be connected to the DN-A7100 for detailed information regarding the HDMI terminal.

* **HDCP: High-bandwidth Digital Content Protection**

CONNECTING HDMI DEVICES

An HDMI cable (sold separately) is used to connect the HDMI jack on the DN-A7100 with the HDMI jack on a DVD player, TV, projector or other component. To transmit multichannel audio via HDMI, the connected player must support multichannel audio transmission through its HDMI jack.

HDMI video streaming is compatible with DVI in principle. Therefore, it is possible to connect to a TV or monitor that has a DVI terminal using an HDMI-DVI conversion cable or plug. When connecting to a DVI terminal, connect the audio signal separately.

Notes:

- Some HDMI components can be controlled over the HDMI cable, but this receiver cannot control other components this way.
- When connected to a monitor (i.e., TV, projector, etc.) that does not support HDCP, video and audio are not output.
- DVI cables come with 24-pin and 29-pin plugs. This receiver supports 24-pin DVI-D cables; 29-pin DVI cables cannot connect to it.
- Some source devices such as DVD players does not support HDMI repeater like those of the DN-A7100. In such case, pictures are not properly projected on monitors such as TVs and projectors.
- When multiple components are connected to this receiver, turn power to unused components off to prevent interference between them.

- Disconnecting or connecting cables with the power on can damage the equipment. Turn the power off before disconnecting or connecting cables.
- Some DVD-Audio disks disable downmixing. These types of disks are not played back correctly unless the left, center, right and surround left and right speakers, and subwoofer are connected.
- If a DVD player that does not support HDMI 1.1 is connected to the DN-A7100, multi channel PCM playback is not possible even with DVD-Audio disks.
- If a DVD player or other device with DVI output is connected to the DN-A7100, a separate audio cable (optical-digital, coaxial digital or analog) is needed for the audio signals. In this case, select the connected audio input as explained in "1 INPUT SETUP". (See page 20)
- Multi channel PCM signals and audio signals of 62 kHz or higher that are input from the HDMI jack are not output from the DIGITAL OUT jacks.
- Depending on the quality of the cable used, the HDMI signal may be affected by noise.
- Audio units that use sampling frequencies of 128 kHz and above are not supported.

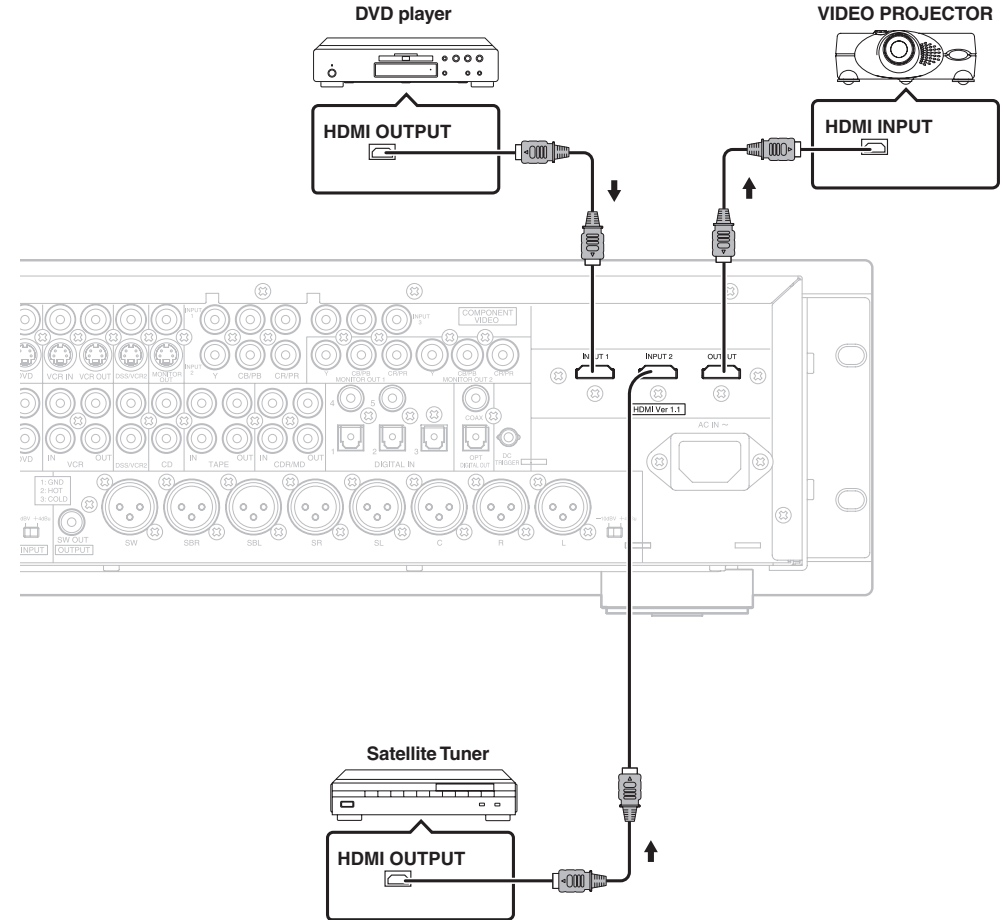

SETUP

After all components are connected, initial setup must be performed.

ON SCREEN DISPLAY MENU SYSTEM

The DN-A7100 incorporates an on-screen menu system, which makes various operations possible by using the cursor (▲, ▼, ◀, ▶) and **ENTER** buttons on the remote control or on the front panel.

Note:

To view the on-screen displays, make certain you have made a connection from the Monitor Out jack on the rear panel to the composite, S-Video, component video input of your TV or projector. (see page 15)

1. Press the **AMP** button of the remote control. (This step is not needed when operating the setup menus from the receiver itself.)
2. Press the **MENU** button on the remote control or set to display the "SETUP MAIN MENU" of the OSD menu system.

There are 7 items in the SETUP MAIN MENU.

3. Select a desired sub-menu with the ▲ or ▼ cursor buttons, and press the **ENTER** button to enter. The display will change to the selected sub-menu. You can lock the condition of setup to each sub-menu with the ◀ or ▶ or cursor buttons.

Note:

If you desire to adjust any sub-menu, you need to set it to UNLOCKED.

4. If you desire to exit from this menu system, press the **EXIT** button, or move the cursor to **EXIT** and press the **ENTER** button.

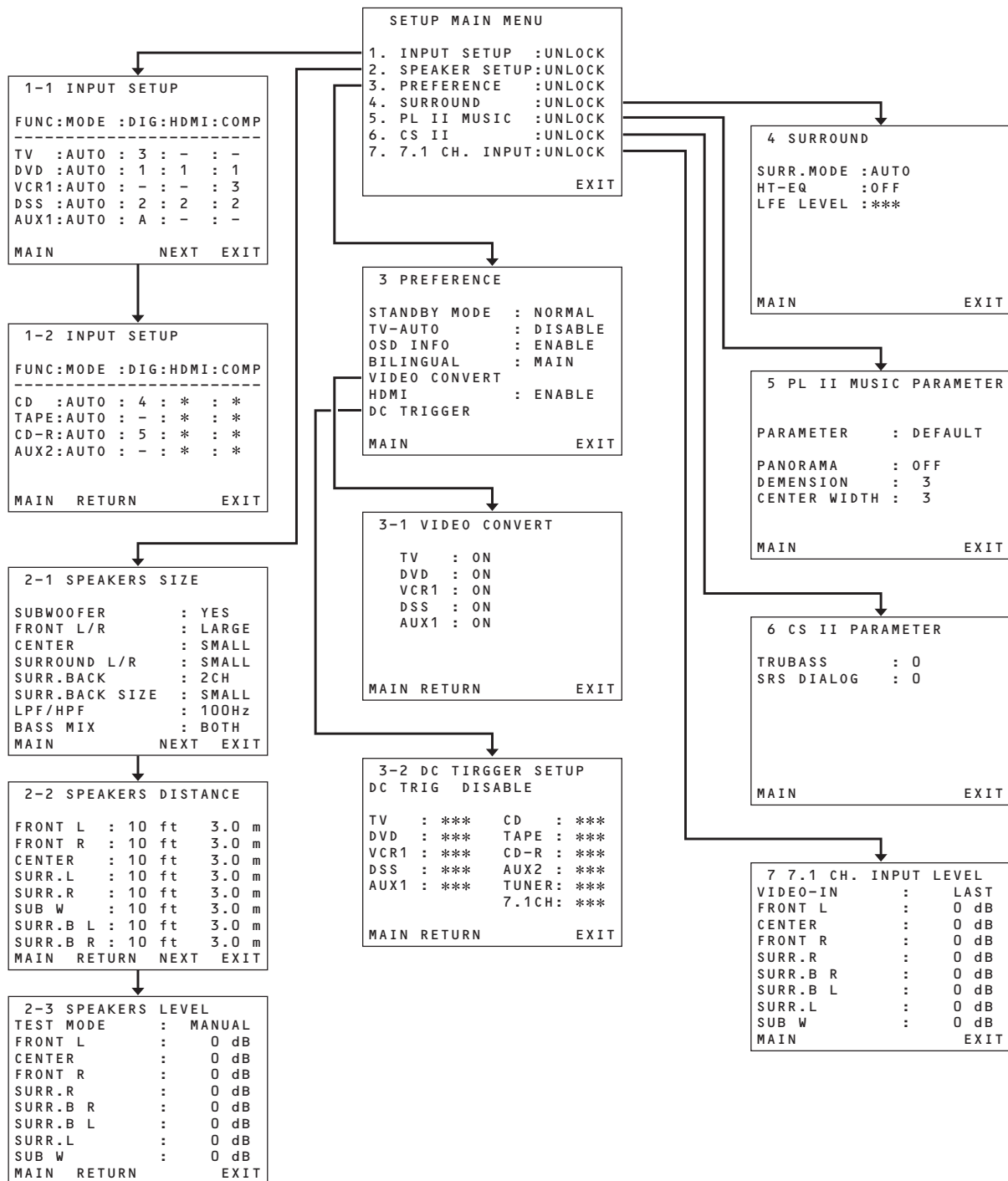

1 INPUT SETUP (ASSIGNABLE DIGITAL INPUT AND COMPONENT VIDEO INPUT)

6 digital inputs, 3 component video inputs and 2 HDMI inputs can be assigned to a desired source. Use this menu to select the digital input jack to be assigned to the input source.

1. Select **"INPUT SETUP"** in SETUP MAIN MENU with ▲ or ▼ cursor button, and press the **ENTER** button.

```

1-1 INPUT SETUP
-----
FUNC:MODE :DIG:HDMI:COMP
-----
TV :AUTO : 3 : - : -
DVD :AUTO : 1 : 1 : 1
VCR1:AUTO : - : - : 3
DSS :AUTO : 2 : 2 : 2
AUX1:AUTO : A : - : -
MAIN      NEXT  EXIT
  
```

```

1-2 INPUT SETUP
-----
FUNC:MODE :DIG:HDMI:COMP
-----
CD :AUTO : 4 : * : *
TAPE:AUTO : - : * : *
CD-R:AUTO : 5 : * : *
AUX2:AUTO : - : * : *
MAIN  RETURN  EXIT
  
```

2. To select the input source and MODE, press the ▲ or ▼ cursor buttons.
3. To select **"DIG"** **"HDMI"** or **"COMP"** for the input jack, press the ◀ or ▶ cursor buttons.
Select **"DIG"** for input sources, for automatic detection of the digital input signal condition.
If there is not a digital signal present, but there is an analog signal present, the analog signal will be played.
Select **"DIG"**, when only a digital signal will be used. Select **"ANA"** for input sources for which no digital input jacks are used.
4. To select the video source, select **"HDMI"** or **"COMP"** by pressing the ▲ or ▼ cursor buttons, and press the ◀ or ▶ cursor buttons to select the video source to be assigned.
5. After you complete this portion of the set up, move the cursor to **MAIN** with the ▲ or ▼ cursor buttons and press the **ENTER** button.

Notes:

- When the TUNER is fixed to the analog input, you can not select any digital input.
- When a DTS-LD or DTS-CD is playing, this setup is not available. This is to avoid noise being generated from the analog input.
- If **"DIG"** is selected and a DVD, compact disc or LD is fast-forwarded during playback, decoded signals may produce a skipping sound. In such cases, change the setting to **DIGITAL**.

2 SPEAKER SETUP

After you have installed the DN-A7100, connected all the components, and determined the speaker layout, it is now time to perform the settings in the Speaker Setup menu for the optimum sound acoustics for your environment and speaker layout.

Before you perform the following settings, it is important that you first determine the following characteristics:

2-1 SPEAKERS SIZE

When setting the speaker size in the **SPEAKER SIZE** sub-menu, use the guidelines given below.

LARGE:

The complete frequency range for the channel you are setting will be output from the speaker.

SMALL:

Frequencies of the channel you are setting lower than approx. 100 Hz will be output from the subwoofer.

If the Subwoofer is set to **"NONE"** and the front speakers are set to **"LARGE,"** then the sound will be output from both the left and right speakers.

```

2-1 SPEAKERS SIZE
-----
SUBWOOFER      : YES
FRONT L/R      : LARGE
CENTER         : SMALL
SURROUND L/R   : SMALL
SURR.BACK      : 2CH
SURR.BACK SIZE : SMALL
LPF/HPF        : 100Hz
BASS MIX       : BOTH
MAIN          NEXT  EXIT
  
```

1. Select **"SPEAKER SETUP"** in SETUP MAIN MENU with ▲ or ▼ cursor button, and press the **ENTER** button.
2. To select the each speaker, press the ▲ or ▼ cursor buttons.
3. To select the setting of each speaker size, press the ◀ or ▶ cursor buttons.
4. After you complete this portion of the set up, move the cursor to **"NEXT"** with the ▲ or ▼ cursor buttons and then press the **ENTER** button to go to the next page.

SUBWOOFER:

YES:

Select when a subwoofer is connected.

NONE:

Select when a subwoofer is not connected.

FRONT L/R

LARGE:

Select if the front speakers are large.

SMALL:

Select if the front speakers are small.

- If **"NONE"** is selected for the Subwoofer setting, then this setting is fixed to **"LARGE."**

CENTER

NONE:

Select if no center speaker is connected.

LARGE:

Select if the center speaker is large.

SMALL:

Select if the center speaker is small.

SURROUND L/R

NONE:

Select if no surround left and right speakers are connected.

LARGE:

Select if the surround left and right speakers are large.

SMALL:

Select if the surround left and right speakers are small.

SURR. BACK

NONE:

Select if no surround back left and right speakers are connected.

2CH:

Select if the surround back left and right speakers are connected.

1CH:

Select if the one surround back speaker is connected.

In this case, the audio signal is emitted from the Surround back L output terminal.

Notes:

- If **"NONE"** is selected for the Surround L/R setting, then this setting is fixed to **"NONE."**

SURR. BACK SIZE

LARGE:

Select if the surround back speaker is large.

SMALL:

Select if the surround back speaker is small.

Note:

If "NONE" is selected for the Surround L/R setting, then this setting is not available.

LPF/HPF

When you use a subwoofer, you can select the cutoff frequency for the small speakers used. Select one of the crossover frequency levels according to the size of the small speaker connected.

80Hz → 100Hz → 120Hz → 150Hz → 180Hz

Notes:

- If using small front speakers, set a slightly higher frequency. If using large front speakers, set a slightly lower frequency.
- If Pure-Direct mode, 7.1CH Input is in use, this function does not take effect.

BASS MIX

- The bass mix setting is only valid when "LARGE" is set for the front speakers and "YES" is set for the subwoofer during stereo playback .

This setting has effect only during playback of PCM or analog stereo sources.

- When "BOTH" is selected, the low frequencies will be played through the main L&R, as well as the sub woofer.

In this playback mode, the low frequency range expand more uniformly through the room, but depending on the size and shape of the room, interference may result in a decrease of the actual volume of the low frequency range.

- By selecting "MIX", the low frequencies will play through the main L&R ONLY.

Note:

LFE signals during playback of Dolby Digital or DTS, will be played through the sub woofer.

2-2 SPEAKERS DISTANCE

Use this parameter to specify the distance of each speaker's position from the listening position. The delay time is automatically calculated according to these distances.

Begin by determining the ideal or most commonly used seating position in the room.

This is important for the timing of the acoustics to create the proper sound space that the DN-A7100 and today's sound systems are able to produce.

Note:

For speakers that you have selected "NONE" the Speaker Configuration sub-menu will not appear here. (There are several useful books and special DVD and LD's available to guide you through proper home theater configuration. If you are unsure, have your DENON dealer perform the installation for you. They are trained professionals familiar with even the most sophisticated custom installations. DENON recommends the WWW.CEDIA.ORG website for further information about this).

2-2 SPEAKERS DISTANCE		
FRONT L	: 10 ft	3.0 m
FRONT R	: 10 ft	3.0 m
CENTER	: 10 ft	3.0 m
SURR.L	: 10 ft	3.0 m
SURR.R	: 10 ft	3.0 m
SUB W	: 10 ft	3.0 m
SURR.B L	: 10 ft	3.0 m
SURR.B R	: 10 ft	3.0 m
MAIN	RETURN	EXIT

1. To select each speaker , press the ▲ or ▼ cursor buttons.
2. To set the distance for each speaker , press the ◀ or ▶ cursor buttons.
3. After you complete this portion of the set up, move the cursor to "NEXT" with the ▲ or ▼ cursor buttons and then press the ENTER button to go to the next page.

FRONT L:

Set the distance from the front left speaker to your normal listening position.

CENTER:

Set the distance from the center speaker to your normal listening position.

FRONT R:

Set the distance from the front right speaker to your normal listening position.

SURR. L:

Set the distance from the surround left speaker to your normal listening position.

SURR. R:

Set the distance from the surround right speaker to your normal listening position.

SUB W:

Set the distance from the subwoofer to your normal listening position.

SURR. B L:

Set the distance from the surround back left speaker to your normal listening position.

SURR. B R:

Set the distance from the surround back right speaker to your normal listening position.

Notes:

- Set the distance to each speaker in meters (m) or feet (ft) as follows.
m: 0.3 - 9 m in 0.3 m steps
ft: 1 - 30 ft in 1 ft steps
- For the speakers that you have selected "NONE" the Speaker Size menu will not appear.
- The setting for Surr.Back L and Surr.Back R appears if you set for it to, two surround back speakers in the Speaker Size menu.
- The setting of Surr.Back appears if it is set for one surround back speaker in the Speaker Size menu.

2-3. SPEAKERS LEVEL SETTING WITH TEST TONE

Here you will set the volume for each speaker so that they are all heard by the listener at the same level. We recommend using a SPL (Sound Pressure Level) meter, when available.

Note:

The speaker level settings are not available in 7.1 Channel Input mode, CS mode and Multi Channel Stereo mode.

2-3 SPEAKERS LEVEL		
TEST MODE	:	MANUAL
FRONT L	:	0 dB
CENTER	:	0 dB
FRONT R	:	0 dB
SURR.R	:	0 dB
SURR.B R	:	0 dB
SURR.B L	:	0 dB
SURR.L	:	0 dB
SUB W	:	0 dB
MAIN	RETURN	EXIT

TEST MODE :

Selects "MANUAL" or "AUTO" for generating the mode of the test tone with the ◀ or ▶ cursor buttons.

If you select "AUTO" , the test tone will be cycled through in a circular pattern which is Left → Center → Right → Surround Right → Surround Back Right → Surround Back Left → Surround Left → Subwoofer → Left → .. increments of 2 seconds for each channel.

Using the ◀ or ▶ cursor buttons, adjust the volume level of the noise from the speaker so that it is the same level for all the speakers.

If you select "MANUAL", adjust the output level of each speaker as listed below.

1. When you move the cursor to FRONT L by pressing the ▼ cursor button, the DN-A7100 will emit a pink noise from the front left speaker. Remember the level of this noise and then press the ▼ cursor button.
(Note that this can be adjusted to any level between -10 and +10 dB in 1 dB intervals except the subwoofer setting. The subwoofer can be adjusted to any level between -15 and +10 dB in 1 dB intervals.)
The DN-A7100 will now emit the pink noise from the center speaker.
2. Using the ◀ and ▶ cursor buttons, adjust the volume level of the noise from the center speaker so that it is the same level as the front left speaker.
3. Press the ▼ cursor button again. The DN-A7100 will now emit the pink noise from the front right speaker.
4. Repeat steps 2 and 3 above for the front right and other speakers until all speakers are adjusted to the same volume level.

After you complete this portion of the set up, press the ENTER button, the cursor will move to "MAIN" and then press the ENTER button to go to SETUP MAIN MENU.

Notes:

- Speakers that you selected "NONE" for in the Speaker Size menu will not appear.
- The setting of Surr.Back L and Surr.Back R appears if you have set it for two surround back speakers in the Speaker Size menu.
- The setting of Surr.Back appears if you have set it for one surround back speaker in the Speaker Size menu.
- To adjust the speaker levels for 7.1-channel input sources, you will need to use the 7.1CH-INPUT sub menu. (See page 23).

3 PREFERENCE

```

3 PREFERENCE
STANDBY MODE : ECONOMY
TV-AUTO      : ***
OSD INFO    : ENABLE
BILINGUAL    : MAIN
VIDEO CONVERT
HDMI        : ENABLE
DC TRIGGER
MAIN                               EXIT

```

1. Select "**PREFERENCE**" in the SETUP MAIN MENU with the ▲ or ▼ cursor buttons, and press the **ENTER** button.
2. To select a desired content, press the ▲ or ▼ cursor buttons.

STANDBY MODE:

When this function is set to "**ECONOMY**", you can reduce the power consumption when the unit is in the standby mode.

Note:

TV-AUTO and RS-232C are disabled in the "**ECONOMY**" setting.

TV AUTO:

Select the TV AUTO ON/OFF function to enable or disable with the ◀ or ▶ cursor buttons.

OSD Info:

Select the OSD information function to enable or disable with the ◀ or ▶ cursor buttons. If you select "**ENABLE**", the DN-A7100 will display the status of the feature (Volume up/down, input select, etc..) on the TV monitor. But if you do not desire this information, select "**DISABLE**".

BILINGUAL:

In the Bilingual mode, Dolby Digital and DTS output is set to either "**MAIN**" or "**SUB**". Select "**BILINGUAL**" with the ◀ and ▶ cursor buttons, then select **MAIN** ↔ **SUB** ↔ **MAIN+SUB** with the ◀ or ▶ cursor buttons.

VIDEO CONVERT:

Select the VIDEO CONVERT function to enable or disable with the ◀ or ▶ cursor buttons. (Video cable connection: Refer to page 15)

```

3-1 VIDEO CONVERT
TV      : ON
DVD     : ON
VCR1    : ON
DSS     : ON
AUX1    : ON
MAIN    RETURN          EXIT

```

After you complete this portion of the set up, move the cursor to "**MAIN**" with the ▲ or ▼ cursor buttons and press the **ENTER** button.

HDMI AUDIO:

This setting determines whether to playback audio input to the HDMI jacks through the DN-A7100 or output it through the receiver to a TV or projector.

ENABLE: The audio input to the HDMI jacks can be played back by this receiver. In such case, audio signals are not output to the TV or projector.

THROUGH: The audio input to the HDMI jacks is not output from the output terminals of the DN-A7100. Audio data is output directly to the TV or projector. This setting is used to listen to audio on a multi channel TV, etc.

DC TRIGGER:

Select "**DC TRIG SETUP**" in the SETUP MAIN MENU with ▲ or ▼ cursor button, and press the **ENTER** button.

```

3-2 DC TRIGGER SETUP
DC TRIG  DISABLE
TV       : ***   CD       : ***
DVD      : ***   TAPE     : ***
VCR1     : ***   CD-R    : ***
DSS      : ***   AUX2     : ***
AUX1     : ***   TUNER   : ***
                          7.1CH : ***
MAIN    RETURN          EXIT

```

You can select MAIN ROOM, REMOTE or DISABLE by pressing ◀ or ▶ cursor buttons.

Notes:

- REMOTE is available for the external control. The RC-1065 cannot operate this function.
- To select desired input source, press ▲ or ▼ cursor button.
- To set ON or OFF, press ◀ or ▶ cursor button.
- After you complete this portion of the set up, move the cursor to "**MAIN**" with the ▲ or ▼ cursor buttons and press the **ENTER** button.

4 SURROUND

```

4 SURROUND
SURR.MODE : AUTO
HT-EQ     : OFF
LFE LEVEL : ***
MAIN                               EXIT

```

1. Select "**SURROUND**" in the SETUP MAIN MENU with the ▲ or ▼ cursor buttons, and press the **ENTER** button.
2. To select a desired content, press the ▲ or ▼ cursor buttons.

SURR.MODE:

Select the desired surround mode with the ◀ or ▶ cursor buttons.

HT-EQ:

Select to active the HT-EQ with the ◀ or ▶ cursor buttons.

The tonal balance of a film soundtrack will be excessively bright and harsh when played back over audio equipment in the home. This is because film soundtracks were designed to be played back in large movie theater environments.

Activating the HT-EQ feature when watching a film made for movie theaters corrects this and restores the correct tonal balance.

The HT-EQ feature is available except in the following modes.

- 7.1 CH INPUT
- PURE-DIRECT
- When VIRTUAL is set for the surround mode

LFE LEVEL:

Select the output level of the LFE signal included in the Dolby Digital signal or the DTS signal.

Select 0 dB, -10 dB or OFF with the ◀ or ▶ cursor buttons.

After you complete this portion of the set up, move the cursor to "**MAIN**" with the ▲ or ▼ cursor buttons and press the **ENTER** button.

5 PL II (PRO LOGIC II) MUSIC PARAMETER

Pro Logic II-Music mode creates a rich and enveloping surround ambience from stereo sources such as CDs.

In this mode, DN-A7100 includes three controls to fine-tune the soundfield as follows.

5 PL II MUSIC PARAMETER	
PARAMETER	: DEFAULT
PANORAMAA	: OFF
DIMENSION	: 3
CENTER WIDTH	: 3
MAIN	EXIT

Select "PL II MUSIC" in the SETUP MAIN MENU with the ▲ or ▼ cursor buttons, and press the ENTER button.

PARAMETER:

Select "DEFAULT" or "CUSTOM" with the ◀ or ▶ cursor buttons.

If you select "CUSTOM", you can adjust three parameters as listed below.

PANORAMA:

Select the Panorama mode On or Off with the ◀ or ▶ cursor buttons.

Panorama wraps the sound of the front left and right speakers around you, for an exciting perspective.

DIMENSION:

Set the Dimension level between +3 and -3 level in 1 level intervals with the ◀ or ▶ cursor buttons.

Adjust the soundfield either towards the front or towards the rear.

This can be useful to help achieve a more suitable balance from all the speakers with certain recordings.

CENTER WIDTH:

Set the Center width level between 0 and 7 in 1 level intervals with the ◀ or ▶ cursor buttons.

Center Width allows you to gradually spread the center channel sound into the front left and right speakers.

At its widest setting, all the sound from the center is mixed into the left and right.

This control may help achieve a more spacious sound or a better blend for the front image.

If "NONE" was selected for the Center speaker setting, in the Speaker size set up menu, then this setting will not appear.

After you complete this portion of the set up, move cursor to "MAIN" with the ▲ or ▼ cursor buttons and press the ENTER button.

6 CS II (CIRCLE SURROUND II) PARAMETER

6 CS II PARAMETER	
TRUBASS	: 0
SRS DIALOG	: 0
MAIN	EXIT

1. Select "CS II" in the SETUP MAIN MENU with the ▲ or ▼ cursor buttons, and press the ENTER button.

2. To Select desired contents as below, press the ▲ or ▼ cursor buttons.

TRUBASS:

Set the TRUBASS level between 0 and 6 level in 1 level interval with the ◀ or ▶ cursor buttons.

TRUBASS produced by the speakers are an octave below the actual physical capabilities of the speakers adding exciting, deeper bass effects.

SRS DIALOG:

Set the SRS DIALOG level between 0 and 6 in 1 level intervals with the ◀ or ▶ cursor buttons.

This can be popped out of the surround audio effects, allowing the listener to easily discern what the actors say.

If "NONE" was selected for the Center speaker setting, in the Speaker size set up menu, then this setting will not appear.

After you complete this portion of the set up, move cursor to "MAIN" with the ▲ or ▼ cursor buttons and press the ENTER button.

7 7.1 CH INPUT LEVEL

This sub-menu is to adjust the speaker levels for 7.1-channel input sources.

Here you will adjust the volume for each channel so that they are all heard by the listener at the same level.

7 7.1 CH. INPUT LEVEL	
VIDEO-IN	: LAST
FRONT L	: 0 dB
CENTER	: 0 dB
FRONT R	: 0 dB
SURR. R	: 0 dB
SURR. B R	: 0 dB
SURR. B L	: 0 dB
SURR. L	: 0 dB
SUB W	: 0 dB
MAIN	EXIT

1. Select "7.1CH INPUT" in the SETUP MAIN MENU with the ▲ or ▼ cursor buttons, and press the ENTER button.

2. To select "VIDEO IN", press ▲ or ▼ cursor button.

3. Using the ◀ or ▶ cursor buttons, select the video input source which is emitted from Monitor out in the 7.1 CH INPUT function.

The input source is switched by pressing the ◀ or ▶ cursor buttons as follows;

LAST ↔ TV ↔ DVD ↔ VCR1 ↔ DSS ↔ AUX1 ↔ V-OFF ↔ LAST ↔

Notes:

- When select LAST, the source is set previous source before 7.1 CH INPUT function is activated.
- When select V-OFF, no signal is emitted from monitor out terminal.

4. To Select desired channel , press the ▲ or ▼ cursor buttons.

5. Using the ◀ or ▶ cursor buttons, adjust the volume level of each channel.

6. After you complete this portion of the set up, move the cursor to "MAIN" with the ▲ or ▼ cursor buttons and press the ENTER button.

Notes:

- These settings will be memorized to 7.1CH INPUT source.
- This feature can be directly selected with the CH-SEL button of the remote controller.

SIMPLE SETUP

You can setup the speaker conditions quickly with SIMPLE SETUP menu. In this menu, the number of speakers and speaker delay time can be set. These settings can be changed more detail in "2. SPEAKER" setup menu.

Press the **SETUP** button on the unit to enter this menu.

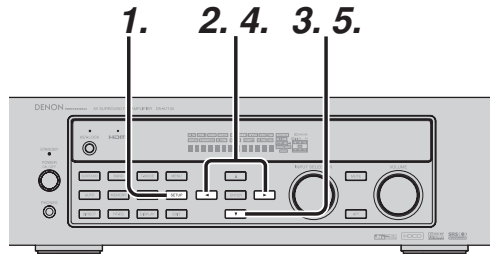

1. Press the **SETUP** button on the unit to enter the "SPEAKERS" menu.
2. Press ◀ or ▶ cursor button to select the speaker number.
3. Press the ▼ cursor button to enter the "ROOM" menu.
4. Press ◀ or ▶ cursor button to select the room size.
5. After finishing all setup, press the ▼ cursor button to exit the SIMPLE SETUP menu.

Note:

All Simple Setup menu is reset when the speaker setting is changed with Speaker Setup menu.

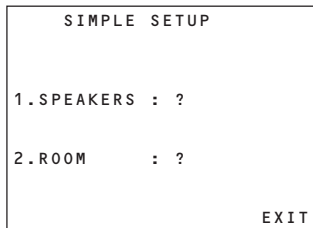

The relation of the speakers number and connected speaker

CHANNEL	Front L/R (F)	Front Center (C)	Surround L/R (S)	Surround Back L/R (SB)	Sub woofer (SW)
7.1 ch	LARGE	SMALL	SMALL	2ch	YES
7.0 ch	LARGE	SMALL	SMALL	2ch	NONE
6.1 ch	LARGE	SMALL	SMALL	1ch	YES
6.0 ch	LARGE	SMALL	SMALL	1ch	NONE
5.1 ch	LARGE	SMALL	SMALL	NONE	YES
5.0 ch	LARGE	SMALL	SMALL	NONE	NONE
4.1 ch	LARGE	NONE	SMALL	NONE	YES
4.0 ch	LARGE	NONE	SMALL	NONE	NONE
3.1 ch	LARGE	SMALL	NONE	NONE	YES
3.0 ch	LARGE	SMALL	NONE	NONE	NONE
2.1 ch	LARGE	NONE	NONE	NONE	YES
2.0 ch	LARGE	NONE	NONE	NONE	NONE

The relation of the room size and floor space

SIZE	Floor space	Width (W)	Depth (D)	Imaging Distance	
				Front (F)	Center (C)
SMALL	10 m ²	2.7 m	3.6 m	Front (F)	6 ft. (1.8 m)
				Center (C)	5 ft. (1.5 m)
				Surround (S)	4 ft. (1.2 m)
				Surr. Back (SB)	5 ft. (1.5 m)
				Sub Woofer (SW)	5 ft. (1.5 m)
MEDIUM	16 m ²	3.6 m	4.5 m	Front (F)	7 ft. (2.1 m)
				Center (C)	6 ft. (1.8 m)
				Surround (S)	5 ft. (1.5 m)
				Surr. Back (SB)	7 ft. (2.1 m)
				Sub Woofer (SW)	6 ft. (1.8 m)
LARGE	24 m ²	4.5 m	5.4 m	Front (F)	9 ft. (2.7 m)
				Center (C)	8 ft. (2.4 m)
				Surround (S)	7 ft. (2.1 m)
				Surr. Back (SB)	8 ft. (2.4 m)
				Sub Woofer (SW)	8 ft. (2.4 m)

The relation of the room size and floor space is a roughly standard.

BASIC OPERATION

(PLAYBACK)

SELECTING AN INPUT SOURCE

Before you can listen to any input media, you must first select the input source on the DN-A7100.

Example : DVD

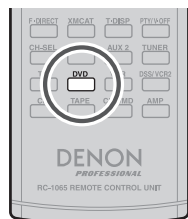

To select DVD, turn the **INPUT SOURCE** knob on the front panel or simply press the **DVD** button on the remote.

After you have selected DVD, simply turn on the DVD player and play the DVD.

- As the input source is changed, the new input name will appear momentarily on the video display. The input name will also appear in the display, on the front-panel.
- As the input is changed, the DN-A7100 will automatically switch to the digital input, surround mode, attenuation, and night mode status which were entered during the configuration process for that source.
- When an audio source is selected, the last video input used remains routed to the **VCR1** Output and **Monitor** Output. This permits simultaneous viewing and listening to different sources.
- When a Video source is selected, the video signal for that input will be routed to the **Monitor Output** jacks and will be viewable on a TV monitor connected to the DN-A7100.

If a component video input is connected to the **DVD** or **DSS** component inputs, it will be routed to the **Component Video Output**. Make certain that your TV is set to the proper input to view the signal.

VIDEO CONVERT

When this function is activated, the video or S-video signal can be emitted from the video, S-video or component video output terminal.

To activate this function, select VIDEO CONVERT in PREFERENCE menu and set ON.

Notes:

- The component video signal is emitted only from component video output terminal.
- When the video equipment is connected by component terminal, connect the monitor and DN-A7100 by the component terminal.
- This function is unavailable for the REC out terminal.
- This function is unavailable for the still picture, fast forward and reverse playing of the video component.
- If, while attempting to use the video convert feature, the DN-A7100 cannot synchronize with the display device, "NO SIGNAL" appears on the monitor, or noise is generated, this feature cannot be used. All of these signs are caused by equipment incompatibility; there is nothing wrong with the DN-A7100.

In such case, set VIDEO CONVERT in the PREFERENCE menu to OFF. Also, connect the video input signal to the display device via the MONITOR OUT terminal under VIDEO and the S-video input signal to the display device via the MONITOR OUT terminal under S-VIDEO.

Example:

Monitor is connected with the component.

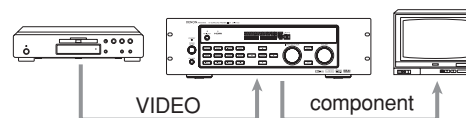

Monitor is connected with the video or S-video.

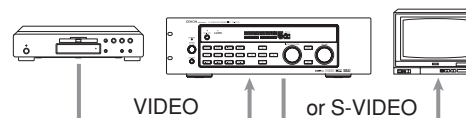

Monitor is connected with the video or component.

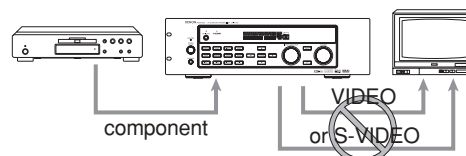
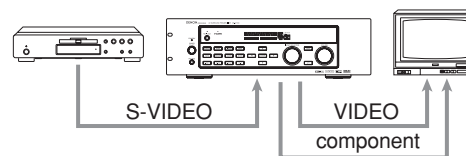

The signal cannot be converted from the component to the video or S-video.

Notes of OSD menu:

- The setup menu can be displayed through all video out (COMPONENT, S-VIDEO, VIDEO).
- The setting informations (e.g. volume setting) are displayed through all video out when the VIDEO CONVERT function are set ON.

Note:

- No setting information is displayed when the signal is emitted from the COMPONENT IN to COMPONENT OUT.
- The setting informations (e.g. volume setting) are displayed through the S-VIDEO or VIDEO out when the VIDEO CONVERT function are set OFF. When the S-VIDEO and VIDEO outputs are used simultaneously, the setting informations are displayed through the S-VIDEO out only.

HDMI

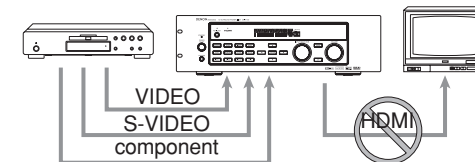
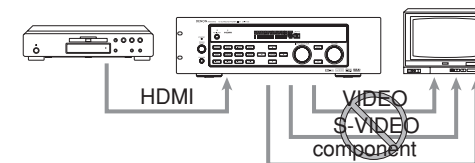

Notes of OSD menu:

HDMI: OSD menu is not displayed.
VIDEO/S-VIDEO/component: VIDEO CONVERT of HDMI is not possible, thus the OSD menu is not displayed.

SELECTING THE SURROUND MODE

Example: AUTO SURROUND

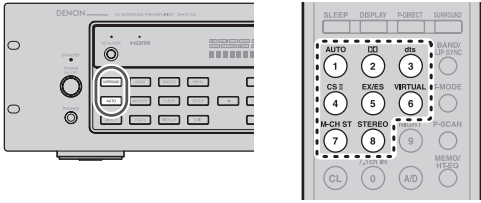

To select the surround mode during playback, press the **SURROUND** button on the front panel or the **SURROUND** buttons on the remote.

ADJUSTING THE MAIN VOLUME

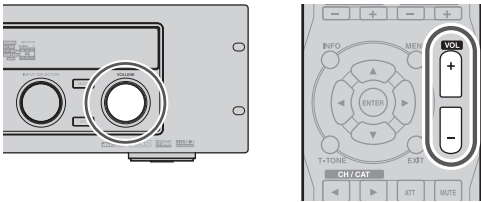

Adjust the volume to a comfortable level using the **VOLUME** control knob on the front panel or **VOL +/-** buttons on the remote.

To increase the volume, turn the **VOLUME** knob clockwise or press **VOL +** button on the remote, to decrease the volume, turn counterclockwise or press **VOL -** button on the remote.

Notes:

- The volume can be adjusted within the range of $-\infty$ to 18 dB, in steps of 1 dB.
- However, when the channel level is set as described on page 21, if the volume for any channel is set at +1 dB or greater, the volume cannot be adjusted up to 18 dB.

(In this case the maximum volume adjustment range is "18 dB - Maximum value of channel level")

ADJUSTING THE TONE (BASS & TREBLE) CONTROL



During a listening session you may wish to adjust the Bass and Treble Control to suit your listening tastes or room acoustics.

(Using the remote control unit)

To adjust the bass effect, press **BASS +** or **BASS -** on the remote.

To adjust the treble effect, press **TREBLE +** or **TREBLE -** on the remote.

Note:

The tone control function can work in the AUTO Surround, Stereo, Dolby PLIIx, DTS, DTS-ES, and Multi Ch. Stereo mode.

TEMPORARILY TURNING OFF THE SOUND

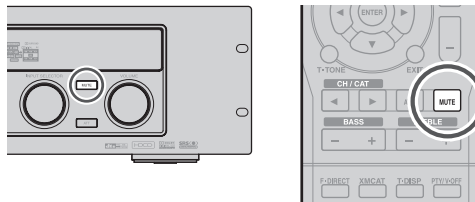

To temporarily silence all speaker outputs such as when interrupted by a phone call, press the **MUTE** button on the front panel or **MUTE** button on the remote.

This will interrupt the output to all speakers and the head-phone jack, but it will not affect any recording or dubbing that may be in progress.

When the system is muted, the display will show "**MUTE**".

Press the **MUTE** button again to return to normal operation.

USING THE SLEEP TIMER



To program the DN-A7100 for automatic standby, press the **SLEEP** button on the remote.

Each press of the button will increase the time before shut down in the following sequence.

OFF

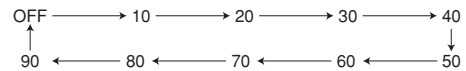

The sleep time will be shown for a few seconds in the display on the front panel, and it will count down until the time has elapsed.

When the programmed sleep time has elapsed, the unit will automatically turn off.

Note that the **SLEEP** indicator on the display will illuminate when the Sleep function is programmed.

To cancel the Sleep function, press the **SLEEP** button until the display shows "SLEEP OFF" and the **SLEEP** indicator will disappear.

NIGHT MODE



Press the **NIGHT** button on the remote to turn on the NIGHT mode.

Selecting the Night Mode ON is effective in Dolby Digital only, and it compresses the dynamic range. This softens loud passages such as sudden explosions, to help prevent disturbing others late at night.

To turn off the Night mode, press the **NIGHT** button again.

SURROUND MODE

The DN-A7100 is equipped with many surround modes. These are provided to reproduce a variety of surround sound effects, according to the content of the source to be played.

The available surround modes may be restricted depending on the input signal and speaker setup.

AUTO

When this mode is selected, the receiver determines whether the digital input signal is Dolby Digital, Dolby Digital Surround EX, DTS, DTS-ES, DTS 96/24 or PCM-audio.

Surround EX & DTS-ES will operate for multichannel source that has a Dolby Digital Surround EX or DTS-ES auto trigger flag in the digital signal.

When a Dolby Digital or DTS signal is input, the number of channels for which the corresponding signal is encoded will be played.

Inputting a Dolby Digital two channel signal with Dolby surround status automatically subjects that signal to Pro Logic IIx movie processing before play. PCM 96 kHz source material can be played in this mode.

Notes:

- When you use this mode with certain DVD and CD players, performing operations such as "Skip" or "Stop" may momentarily interrupt the output.
- When the signal is not decoded, the mode is changed to AUTO mode automatically. Refer to page 29 to confirm the available decoding mode.

DD MODE

(Dolby Digital, Pro Logic IIx MOVIE, Pro Logic IIx MUSIC, Pro Logic IIx GAME, Pro Logic)

This mode is used with source materials encoded in Dolby Digital and Dolby Surround.

DOLBY DIGITAL

This mode is enabled when playing source materials encoded in Dolby Digital.

Playing multichannel encoded 6.1 or 7.1-channel Dolby Digital sources provides five main audio channels (left, center, right, surround left and surround right) and Low Frequency Effect channel.

Dolby Digital EX decoding is not available in this mode.

Dolby Pro Logic IIx brings the excitement of surround sound to any stereo mix, while making existing Dolby Surround mixes sound more like discrete 5.1 channels Surround sound.

Dolby Pro Logic IIx has 3 modes. Please see below.

Pro Logic IIx MOVIE

This mode provides 6.1 or 7.1 channel surround sound from Dolby Surround encoded stereo movie sound tracks.

Pro Logic IIx MUSIC

This mode provides 6.1 or 7.1 channel surround sound from conventional stereo sources, analog or digital, such as CD, Tape, FM, TV, Stereo VCR, etc.

Pro Logic IIx GAME

Game mode restores the impact low-frequency surround effects by routing them to the system's subwoofer.

Pro Logic

This mode emulated original Dolby Pro Logic decoding (3/1 surround) suit for Dolby Surround encoded stereo movie soundtracks.

Notes:

- Pro Logic IIx mode will decode as Pro Logic II mode when the SURROUND BACK SPEAKER is set NONE in SPEAKER SETUP menu. (See SPEAKER SETUP, page 20)
- Pro Logic IIx mode is available for a 2ch input signal which is encoded in Dolby Digital or PCM format.
- PCM-audio signals can be subjected to Pro Logic processing when the sampling frequency is 32 kHz, 44.1 kHz or 48 kHz.

EX/ES

This mode provides 6.1 channel surround for DOLBY DIGITAL EX, DTS-ES encoded source material such as DVD.

This mode cannot be used when an analog input has been selected.

Dolby Digital EX

In a movie theater, film soundtracks that have been encoded with Dolby Digital surround EX technology are able to reproduce an extra channel which has been added during the mixing of the program.

This channel, called Surround Back, places sounds behind the listener in addition to the currently available front left, front center, front right, surround right, surround left and subwoofer channels.

This additional channel provides the opportunity for more detailed imaging behind the listener and brings more depth, spacious ambience and sound localization than ever before.

Dolby Digital EX is not available in the system without surround back speaker(s).

DTS-ES (Discrete 6.1, Matrix 6.1)

DTS-ES adds the surround back channel audio to the DTS 5.1-channel format to improve the acoustic positioning and makes acoustic image movement more natural with the 6.1-channel reproduction.

This receiver incorporates a DTS-ES decoder, which can handle DTS-ES Discrete-encoded and DTS-ES Matrix-encoded program sources from DVD, etc..

DTS-ES Discrete 6.1 features digital discrete recording of all channels including the surround back channel(s) and higher quality of audio reproduction. DTS-ES is not available in the system without a surround back speaker.

dts MODE

(dts, Neo:6 Cinema, Neo:6 Music)

This mode is for DTS encoded source materials such as LASER DISC, CD, and DVD. Neo:6 is for some 2 channel sources.

dts : This mode is enabled when playing source materials encoded in dts multichannel.

Playing multichannel encoded 5.1-channel dts sources provides five main audio channels (left, center, right, surround left and surround right) and Low Frequency Effect channel.

dts-ES decoding is not available in this mode.

The DTS mode cannot be used when an analog input has been selected.

Neo:6 Cinema, Neo:6 Music

This mode decodes 2-channel signals into 6-channel signals using high-accuracy digital matrix technology.

The DTS NEO:6 decoder has near-discrete properties in the frequency characteristics of the channels as well as in channel separation.

According to the signals to be played back, DTS NEO:6 uses either the NEO:6 CINEMA mode optimized for movie playback or the NEO:6 MUSIC mode optimized for music playback.

Notes:

- Neo:6 mode is available to 2ch input signals which are encoded in Dolby Digital or PCM Analog format.
- PCM-audio signals can be subjected to Pro Logic processing when the sampling frequency is 32 kHz, 44.1 kHz or 48 kHz.

MULTI CH. ST

This mode is used to create a wider, deeper and more natural soundstage from two channel source material.

This is done by feeding the left channel signal to both left front and left surround speaker and the right channel signal to both right front and right surround speaker. Additionally, the center channel reproduces a mix of the right and left channel.

CIRCLE SURROUND II

(CSII-CINEMA, CSII-MUSIC, CSII-MONO)

Circle Surround is designed to enable multichannel surround sound playback of non-encoded and multichannel encoded material.

Backward compatibility provides listeners with up to 6.1 channels of surround performance from entire collection of music and film, including broadcast, videotape and stereo recorded music.

Depending on source material, you can select **CSII-Cinema** mode, **CSII-Music** mode or **CSII-Mono** mode.

CSII Cinema mode

This mode is suited for playing back Circle Surround-encoded and non-encoded film and television soundtracks. Cinema Mode enables 6.1-channel surround playback of 2-channel sources such as Video Cassettes, TV broadcasts, streaming media and DVDs.

CSII Music mode

This mode is suited for playing back Circle Surround-encoded and non-encoded music. Music Mode decodes, music DVDs, radio and TV music broadcasts and CDs into enveloping 6.1-channel surround.

CSII-Mono mode

This mode plays back monaural recordings from any source, including CDs, DVDs and TV and radio broadcasts in compelling 6.1-channel surround.

Notes:

- CS II mode is available for 2ch input signals which are encoded in Dolby Digital or PCM format.
- PCM-audio signals can be subjected to Pro Logic processing when the sampling frequency is 32 kHz, 44.1 kHz or 48 kHz.

VIRTUAL

This mode creates a virtualized surround sound experience from a two-speaker (front L and R) playback system playing any multichannel audio source (such as found on DVDs and digital broadcasts), including Dolby Digital, Dolby Pro Logic or DTS.

STEREO

This mode bypasses all surround processing. In stereo program sources, the left and right channels play normally when PCM-audio or analog stereo is input.

With Dolby Digital and DTS sources, the 5.1 multichannels are converted to two channel stereo. 96 kHz PCM source material can be played back in stereo mode.

SOURCE DIRECT

In the Source Direct mode, the tone control circuit and bass management configuration are bypassed for full-range frequency response and the purist audio reproduction.

Notes:

- Speaker size is set to Front L/R = LARGE, Center = LARGE, Surround L/R = LARGE and Subwoofer = YES automatically. Tone controls, equalizer and additional processing are deactivated.
- When you use this mode with certain DVD and CD players, performing operations such as skip or stop may momentarily interrupt the output.

PURE DIRECT

The Pure Direct mode further reduces sources of noise in addition to effect of the Source Direct mode, by blocking output from the video jacks (VIDEO, S-VIDEO, COMPONENT VIDEO and HDMI) and turning the FL display off.

CAUTION**NOTE for DTS signal**

- * Connected DVD player, laserdisc player or CD player needs to support DTS digital output. You may not be able to play some DTS source signals from certain CD players and LD players even if you connect the player to the DN-A7100 digitally. This is because the digital signal has been processed (such as the output level, sampling frequency or frequency response), and the DN-A7100 cannot recognize the signal as DTS data.
- * Depending on the player used, DTS play may produce a short noise. This is not a malfunction.
- * While signals from a DTS laserdisc or CD are playing in another surround mode, you cannot switch to digital input or from digital input to analog input from the INPUT SETUP in the MAIN MENU or by pressing the **A/D** button.
- * The outputs for VCR OUT, TAPE OUT, and CD-R/MD OUT output analog audio signals only. Do not record from CDs or LDs that support DTS using these outputs. If you do, the DTS-encoded signal will be recorded as noise.

NOTE for Dolby Digital Surround EX signal

- * When playing Dolby Digital Surround EX-encoded software in 6.1 channels, it is required to set the EX/ES mode.
- * Note that some of Dolby Digital Surround EX-encoded software does not contain the identification signal. In this case, set the EX/ES mode manually.

NOTE for 96kHz PCM audio

- * AUTO, PURE-DIRECT, and STEREO modes can be used when playing PCM signals with a sampling frequency of 96 kHz (such as from DVDVideo discs that contain 24 bit, 96 kHz audio). If such signals are input during playback in one of the other surround modes, output from DN-A7100 will be muted.
- * Certain DVD player models inhibit digital output. For details, refer to the player's operation manual.
- * Some DVD formatted discs feature copy protection. When using such disc, 96 kHz PCM signal is not output from the DVD player. For details, refer to the player's operation manual.

NOTE for HDCD signal

- * HDCD is effective only through digital input.
- * You may not be able to play some HDCD source signals from certain CD players if you connect the player to the DN-A7100 digitally. This is because the digital signal has been processed (such as the output level, sampling frequency or frequency response) and the DN-A7100 cannot recognize the signal as HDCD data.

The relation between the selected surround mode and the input signal

The surround mode is selected with the surround mode selector on DN-A7100 or the remote control unit. However, the sound you hear is subject to the relationship between the selected surround mode and input signal. That relationship is as follows;

Surround Mode	Input Signal	Decoding	Output Channel					Front information display		
			L/R	C	SL SR	SBL SBR	SubW	Signal format indicators	Channel status	
AUTO	Dolby Surr. EX	Dolby Digital EX	○	○	○	○	○	DD DIGITAL	L, C, R, SL, SR, S, LFE	
	Dolby D (5.1ch)	Dolby Digital 5.1	○	○	○	-	○	DD DIGITAL	L, C, R, SL, SR, LFE	
	Dolby D (2ch)	Dolby Digital 2.0	○	-	-	-	-	DD DIGITAL	L, R	
	Dolby D (2ch Surr)	Pro Logic IIx movie	○	○	○	○	-	DD DIGITAL, DD SURROUND	L, R, S	
	DTS-ES	DTS-ES	○	○	○	○	○	dts, ES	L, C, R, SL, SR, S, LFE	
	DTS 96/24	DTS 96/24	○	○	○	-	○	dts 96/24	L, C, R, SL, SR, LFE	
	DTS (5.1ch)	DTS 5.1	○	○	○	-	○	dts	L, C, R, SL, SR, LFE	
	Multi Ch-PCM	Multi Ch-PCM	○	○	○	-	○	PCM	L, C, R, SL, SR, LFE	
	Multi Ch-PCM 96kHz	Multi Ch-PCM 96kHz	○	○	○	-	○	PCM	L, C, R, SL, SR, LFE	
	PCM(Audio)	PCM (Stereo)	○	-	-	-	-	PCM	L, R	
	PCM 96kHz	PCM (96kHz Stereo)	○	-	-	-	-	PCM	L, R	
	HDCD	PCM (Stereo)	○	-	-	-	-	PCM HDCD	L, R	
	Analog	Stereo	○	-	-	-	-	ANALOG	-	
	SOURCE DIRECT PURE DIRECT	Dolby D Surr. EX	Dolby Digital EX	○	○	○	○	○	DD DIGITAL	L, C, R, SL, SR, S, LFE
		Dolby D (5.1ch)	Dolby Digital 5.1	○	○	○	-	○	DD DIGITAL	L, C, R, SL, SR, LFE
Dolby D (2ch)		Dolby Digital 2.0	○	-	-	-	-	DD DIGITAL	L, R	
Dolby D (2ch Surr)		Pro Logic IIx movie	○	○	○	○	-	DD DIGITAL, DD SURROUND	L, R, S	
DTS-ES		DTS-ES	○	○	○	○	○	dts, ES	L, C, R, SL, SR, S, LFE	
DTS 96/24		DTS 96/24	○	○	○	-	○	dts 96/24	L, C, R, SL, SR, LFE	
DTS (5.1ch)		DTS 5.1	○	○	○	-	○	dts	L, C, R, SL, SR, LFE	
Multi Ch-PCM		Multi Ch-PCM	○	○	○	-	○	PCM	L, C, R, SL, SR, LFE	
Multi Ch-PCM 96kHz		Multi Ch-PCM 96kHz	○	○	○	-	○	PCM	L, C, R, SL, SR, LFE	
PCM (Audio)		PCM (Stereo)	○	-	-	-	-	PCM	L, R	
PCM 96kHz		PCM (96kHz Stereo)	○	-	-	-	-	PCM	L, R	
HDCD		PCM (Stereo)	○	-	-	-	-	PCM HDCD	L, R	
Analog		Stereo	○	-	-	-	-	ANALOG	-	
EX/ES		Dolby D Surr. EX	Dolby Digital EX	○	○	○	○	○	DD DIGITAL	L, C, R, SL, SR, S, LFE
		Dolby D (5.1ch)	Dolby Digital EX	○	○	○	○	○	DD DIGITAL	L, C, R, SL, SR, LFE
	DTS-ES	DTS-ES	○	○	○	○	○	dts, ES	L, C, R, SL, SR, S, LFE	
	DTS(5.1ch)	DTS-ES	○	○	○	○	○	dts	L, C, R, SL, SR, LFE	
	Multi-PCM	Multi Ch-PCM + Dolby EX	○	○	○	○	○	PCM	L, C, R, SL, SR, LFE	
	AAC (5.1ch)	AAC EX	○	○	○	-	○	AAC	L, C, R, SL, SR, LFE	
	DOLBY (PL IIx movie) (PL IIx music) (PL IIx game) (Pro Logic)	Dolby D Surr. EX	Dolby Digital 5.1	○	○	○	○	○	DD DIGITAL	L, C, R, SL, SR, S, LFE
		Dolby D (5.1ch)	Dolby Digital 5.1	○	○	○	○	○	DD DIGITAL	L, C, R, SL, SR, LFE
		Dolby D (2ch)	Pro Logic IIx	○	○	○	-	○	DD DIGITAL	L, R
		Dolby D (2ch Surr)	Pro Logic IIx	○	○	○	○	-	DD DIGITAL, DD SURROUND	L, R, S
		Multi Ch-PCM	Multi Ch-PCM + PLIIx	○	○	○	○	○	PCM	L, C, R, SL, SR, LFE
		PCM (Audio)	Pro Logic IIx	○	○	○	-	○	PCM	L, R
	DTS (Neo:6 Cinema) (Neo:6 Music)	Analog	Pro Logic IIx	○	○	○	○	-	ANALOG	-
		DTS-ES	DTS 5.1	○	○	○	-	○	dts, ES	L, C, R, SL, SR, S, LFE
		DTS 96/24	DTS 96/24	○	○	○	-	○	dts 96/24	L, C, R, SL, SR, LFE
DTS (5.1ch)		DTS 5.1	○	○	○	-	○	dts	L, C, R, SL, SR, LFE	
PCM (Audio)		Neo:6	○	○	○	-	○	PCM	L, R	
Analog		Neo:6	○	○	○	-	○	ANALOG	-	
Dolby D (2ch)		Neo:6	○	○	○	-	○	DD DIGITAL	L, R	
Dolby D (2ch Surr)		Neo:6	○	○	○	-	○	DD DIGITAL, DD SURROUND	L, R, S	
PCM (Audio)		CS II	○	○	○	○	○	PCM	L, R	
CS II Cinema CS II Music CS II Mono	Analog	CS II	○	○	○	○	○	ANALOG	-	
	Dolby D (2ch)	CS II	○	○	○	○	○	DD DIGITAL	L, R	
	Dolby D (2ch Surr)	CS II	○	○	○	○	○	DD DIGITAL, DD SURROUND	L, R, S	
	Dolby Surr. EX	Stereo	○	-	-	-	○	DD DIGITAL	L, C, R, SL, SR, S, LFE	
STEREO	Dolby Surr. EX	Stereo	○	-	-	-	○	DD DIGITAL	L, C, R, SL, SR, S, LFE	
	Dolby D (5.1ch)	Stereo	○	-	-	-	○	DD DIGITAL	L, C, R, SL, SR, LFE	
	Dolby D (2ch)	Stereo	○	-	-	-	○	DD DIGITAL	L, R	
	Dolby D (2ch Surr)	Stereo	○	-	-	-	○	DD DIGITAL, DD SURROUND	L, R, S	
	DTS-ES	Stereo	○	-	-	-	○	dts, ES	L, C, R, SL, SR, S, LFE	
	DTS 96/24	Stereo	○	-	-	-	○	dts 96/24	L, C, R, SL, SR, LFE	
	DTS (5.1ch)	Stereo	○	-	-	-	○	dts	L, C, R, SL, SR, LFE	
	Multi Ch-PCM	Stereo	○	-	-	-	○	PCM	L, C, R, SL, SR, LFE	
	PCM (Audio)	Stereo	○	-	-	-	○	PCM	L, R	
	PCM 96kHz	Stereo	○	-	-	-	○	PCM	L, R	
	HDCD	PCM (Stereo)	○	-	-	-	○	PCM HDCD	L, R	
Analog	Stereo	○	-	-	-	○	ANALOG	-		

Surround Mode	Input Signal	Decoding	Output Channel					Front information display	
			L/R	C	SL SR	SBL SBR	SubW	Signal format indicators	Channel status
Virtual	Dolby Surr. EX	Virtual	○	-	-	-	-	DD DIGITAL	L, C, R, SL, SR, S, LFE
	Dolby D (5.1ch)	Virtual	○	-	-	-	-	DD DIGITAL	L, C, R, SL, SR, LFE
	Dolby D (2ch)	Virtual	○	-	-	-	-	DD DIGITAL	L, R
	Dolby D (2ch Surr)	Virtual	○	-	-	-	-	DD DIGITAL, DD SURROUND	L, R, S
	DTS-ES	Virtual	○	-	-	-	-	dts, ES	L, C, R, SL, SR, S, LFE
	DTS (5.1ch)	Virtual	○	-	-	-	-	dts	L, C, R, SL, SR, LFE
	PCM (Audio)	Virtual	○	-	-	-	-	PCM	L, R
	Analog	Virtual	○	-	-	-	-	ANALOG	-
Multi Ch. Stereo	Dolby Surr. EX	Dolby Digital EX	○	○	○	○	○	DD DIGITAL	L, C, R, SL, SR, S, LFE
	Dolby D (5.1ch)	Dolby Digital 5.1	○	○	○	-	○	DD DIGITAL	L, C, R, SL, SR, LFE
	Dolby D (2ch)	Multi Channel Stereo	○	○	○	-	○	DD DIGITAL	L, R
	Dolby D (2ch Surr)	Multi Channel Stereo	○	○	○	-	○	DD DIGITAL, DD SURROUND	L, R, S
	DTS-ES	DTS-ES	○	○	○	○	○	dts, ES	L, C, R, SL, SR, S, LFE
	DTS (5.1ch)	DTS 5.1	○	○	○	-	○	dts	L, C, R, SL, SR, LFE
	Multi Ch-PCM	Multi Ch-PCM	○	○	○	-	○	PCM	L, C, R, SL, SR, LFE
	Multi Ch-PCM 96kHz	Multi Ch-PCM 96kHz	○	○	○	-	○	PCM	L, C, R, SL, SR, LFE
PCM (Audio)	Multi Channel Stereo	○	○	○	-	○	PCM	L, R	
Analog	Multi Channel Stereo	○	○	○	-	○	ANALOG	-	

Notes:

- Dolby Digital (2 ch: Lt/Rt): signal with Dolby Surround flag Speakers are full set.
- No sound outputs from the surround speaker, center speaker and subwoofer if the DVD disc has no surround data.

Abbreviations

- L/R : Front speakers
- C : Center speaker
- SL/SR : Surround speakers
- SBL/SBR : Surround Back speakers
- SubW : Sub woofer speaker

OTHER FUNCTION

TV AUTO ON/OFF FUNCTION

This function allows the component connected to the TV-VIDEO in jack to control the power (ON/OFF) to the DN-A7100.

AUTO POWER ON

1. Be sure the TV auto mode is ENABLED. (Refer page 22 : System Setup)
2. Connect your TV TUNER (etc) to the TV-VIDEO in terminal. Be sure to connect the VIDEO input.
3. Turn OFF the power to the TV TUNER and the DN-A7100.
4. Turn ON the TV TUNER and tune in a receivable station.
5. When the station is received, the DN-A7100 turns ON and TV is selected automatically.

AUTO POWER OFF

1. In the above situation, turn the TV TUNER OFF or select a channel that does not contain any broadcast.
2. The power to the DN-A7100 switches to STANDBY after approx. 5 minutes.

Notes:

- AUTO POWER OFF is canceled if the DN-A7100 is set to a source other than TV. The function reactivates when TV is selected again.
- Some TV broadcasts may cause the TV AUTO FUNCTION to turn ON.
- The S-Video terminal does not support "TV AUTO ON/OFF" function.

ATTENUATION TO ANALOG INPUT SIGNAL



If the selected analog audio input signal is greater than the capable level of internal processing, the "PEAK" indicator will light up on the front display. If this happens, you should press the **ATT** button on the remote.

"ATT" indicator will be illuminated when this function is activated. The signal-input level is reduced by about half. Attenuation will not work with the output signal of TAPE-OUT, CD-R/MD-OUT and VCR-OUT.

This function is memorized for each individual input source.

LISTENING THROUGH HEADPHONES

This jack may be used to listen to the DN-A7100's output through a pair of headphones. Be certain that the headphones have a standard 1/4" stereo phono plug.

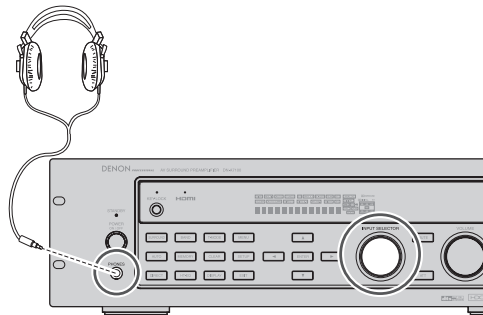

VIDEO ON/OFF

When no video signal is connected to the DN-A7100 or a DVD, etc., is connected directly to your TV, the unnecessary video circuit can be turned off by selecting the "VIDEO OFF" setting.

To select video off, press the **AMP** button and press the **V-OFF** button.

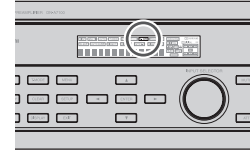

DISPLAY MODE

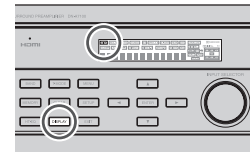

You can select the display mode for the front display of the DN-A7100.

To select this mode, press the **DISPLAY** on the remote control.

When this button is pressed, the display mode is switched in the following sequence.

→ Surround Mode → Auto-display Off → Display Off → Input Function → Surround Mode...

In Auto display off mode, the display is off. But, if you make a change to the unit such as input or surround mode, the display will show that change, then go back to off after about 3 seconds. When changing the volume, it is not displayed.

In Display off mode, the display is off completely.

Note:

Only the DISP indicator will be illuminated on the front display in display off condition

SELECTING ANALOG AUDIO INPUT OR DIGITAL AUDIO INPUT

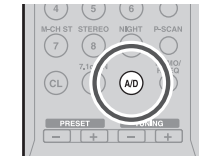
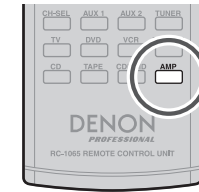

If you have already assigned the digital inputs, you can temporarily select the audio input mode for each input source as following procedures.

Press the **AMP** button and press the **A/D** button.

When this button is pressed, the input mode is switched in the following sequence.

→ HDMI Auto → HDMI → Digital Auto → Digital

→ Analog → HDMI Auto...

In HDMI Auto mode, the types of signals being input to the digital and analog input jacks for the selected input source are detected automatically.

If no digital signal is being input, the analog input jacks are selected automatically.

In Digital and HDMI mode, input is fixed to an assigned digital input terminal.

In analog mode, the analog input jacks are selected.

This selecting is temporary, so the result will not be stored in memory.

If you need to change the input mode completely, use **INPUT SETUP** in OSD menu system. (see page 20)

RECORDING AN ANALOG SOURCE

In normal operation, the audio or video source selected for listening through the DN-A7100 is sent to the record outputs.

This means that any program you are watching or listening to may be recorded simply by placing machines connected to the outputs for **TAPE OUT**, **CD-R/MD OUT**, **VCR OUT** in the record mode.

To record the input source signal you are currently watching or listening to

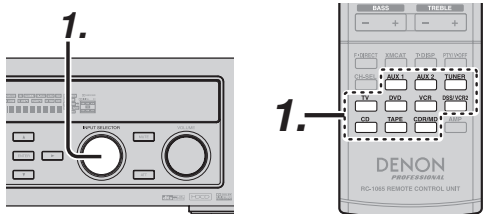

1. Select the input source to record by turning the **INPUT SOURCE** knob on the front panel or simply press the **input selector** buttons on the remote.

The input source is now selected and you may watch or listen to it as desired.

2. The currently selected input source signal is output to the **TAPE OUT**, **CD-R/MD OUT**, **VCR OUT** outputs for recording.

3. Start recording to the recording component as desired.

Recording the video from one source and the audio from another

You can add the sound from one source to the video of another source to make your own video recordings.

Below is an example of recording the sound from a compact disc player connected to CD IN and the video from a video camera connected to DSS/VCR2 to video cassette recorder connected to the VCR OUT jack.

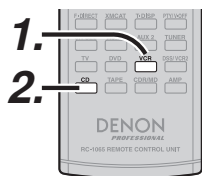

1. Switch the video output source to VCR1 by simply pressing the **input selector** buttons on the remote.
2. Switch the audio input source to CD by simply pressing the **input selector** buttons on the remote.
3. Now "CD" has been selected as the audio input source and "VCR1" as the video input source.

Notes:

- If you change the input source during recording, you will record the signals from the newly selected input source.
- You cannot record the surround effects.
- Digital input signals are only output to the digital outputs. There is no conversion from digital to analog.

When connecting CD players and other digital components, do not connect only the digital terminals, but the analog ones as well.

HT-EQ (HOME THEATER EQUALIZER)

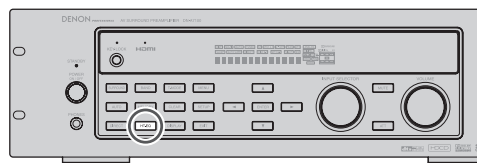

At cinemas, the front left, front right and center speakers are located behind the screen. So, screen damping is taken into account when mastering movie software, with an emphasis on high frequencies. When playing back such software at home, the signal takes on different characteristics from those at the cinema. This unit includes HT-EQ to rectify the sound difference between that experienced at a cinema and in a home theater, allowing you to enjoy the same sound you would experience at the cinema at home. The HT-EQ feature is available except in the following modes.

- 7.1 CH INPUT
- PURE-DIRECT
- When VIRTUAL is set for the surround mode

1. Press the HT-EQ button on the unit.

"EQ" indicator on the front panel will illuminate, indicating the HOME THEATER EQUALIZER has been activated.

2. To cancel this function, press the HT-EQ button again.

"EQ" indicator on the front panel will be turned off, indicating the HOME THEATER EQUALIZER has been deactivated.

7.1 CH INPUT

The DN-A7100 is equipped for future expansion through the use of Multi channel Super Audio CD multichannel player or DVD-Audio player.

When this is selected, the input signals connected to the L (front left), R (front right), CENTER, SL (surround left), SR (surround right) and SBL (surround back left) and SBR (surround back right) channels of the 7.1 CH. In jacks are output directly to the front (left and right), center, surround (left and right) and surround back the pre-out jacks without passing through the surround circuitry.

When 7.1 CH. INPUT is selected, the last video input used remains routed to the **Monitor Outputs**.

This permits simultaneous viewing with video sources.

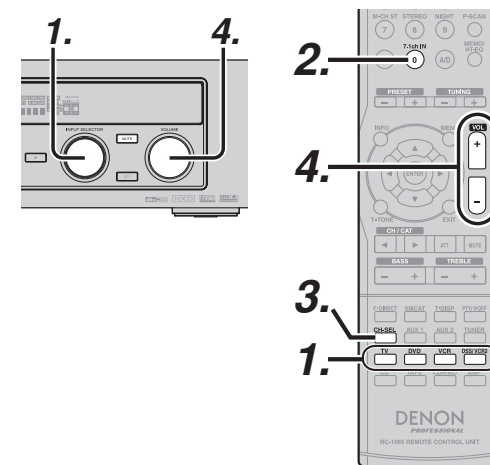

1. Select a desired Video source to decide the routed video signal to the **Monitor Outputs**.
2. Press **7.1 CH IN** on the remote to switch the 7.1 channel input.
3. If it is necessary to adjust the output level of each channel, press the **CH.SEL** button on the remote.

Adjust the speaker output levels so that you can hear the same sound level from each speaker at the listening position. For the front left, front right, center, surround left, surround right and surround back speakers, the output levels can be adjusted between -10 to +10 dB.

The subwoofer can be adjusted between -15 and +10 dB.

These adjustments result will be stored to 7.1 CH. INPUT memory.

4. Adjust the main volume with the **VOLUME** knob or the **VOL -/+** buttons on the remote.

To cancel the 7.1 CH. INPUT setting, press **7.1 CH IN** on the remote.

Notes:

- 7.1 CH. Input mode bypasses the internal surround processing, so SURROUND mode cannot be selected.
- In addition, there is no signal at the record outputs when the 7.1 CH. Input is in use.

AUX2 INPUT

If you don't need to connect 7.1 Ch. input terminals with multi channel decoder, L(front left) and R (front right) inputs terminals are available as AUX2 input.

In this case, You can connect additional audio source to AUX2 as other audio input terminals.

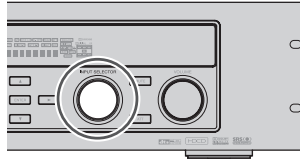

LIP.SYNC

Depending on the image device (TV, monitor, projector, etc.) connected to the DN-A7100, a time lag can occur between image signal processing and audio signal processing. Though minor, this time lag can interfere with movie and music enjoyment. The LIP.SYNC feature delays the audio signal with respect to the image signal output from the DN-A7100 to correct the time lag between the sound and image. It can be operated with the "LIP.SYNC" and ◀ and ▶ cursor buttons of the remote controller. Set the remote controller to the AMP mode before operating the LIP.SYNC feature. The initial setting is OFF (0 ms).The time lag can be adjusted in 10 ms steps up to 200 ms.

Watch the picture on the image device (i.e., TV, monitor, projector, etc.) as you adjust the time lag.

Note:

The LIP.SYSNC feature turns OFF (0 ms) in the PURE DIRECT mode. When the PURE DIRECT mode is deactivated, the set value of the LIP.SYSNC feature is automatically restored.

BASIC OPERATION (TUNER)

LISTENING TO THE TUNER

Frequency scan step for AM is selectable. Default setup is 9 kHz step, if your country's standard is 10 kHz step, Press **BAND** button on the remote more than 6 seconds. Scan step will change.

Note:

Preset memory for the tuner will clear by changing this setup.

AUTO TUNING

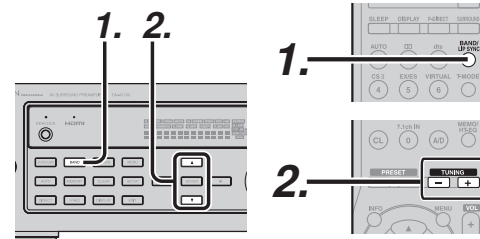

(Using the DN-A7100)

1. To select tuner and desired band (FM or AM), press the **BAND** button on the front panel.
2. Press the ▲ or ▼ cursor buttons on the front panel for more than 1 second to start the auto tuning function.
3. Automatic searching begins then stops when a station is tuned in.

(Using the remote control unit)

1. To select tuner and desired band (FM or AM), press the **BAND** button on the remote.
2. Press the **TUNING -/+** for more than 1 second on the remote.
3. Automatic searching begins then stops when a station is tuned in.

If tuning does not stop at the desired station, use to the "Manual tuning" operation.

MANUAL TUNING

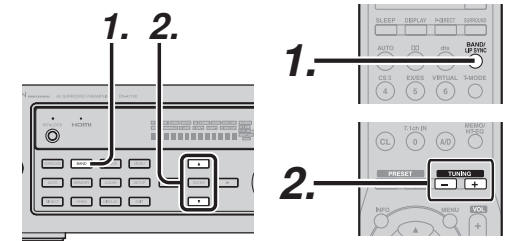

(Using the DN-A7100)

1. To select tuner and desired band (FM or AM), press the **BAND** button on the front panel.
2. Press the ▲ or ▼ cursor buttons on the front panel to select the desired station.

(Using the remote control unit)

1. To select tuner and desired band (FM or AM), press the **BAND** button on the remote.
2. Press the **TUNING -/+** on the remote to tune in the desired station.

DIRECT FREQUENCY CALL

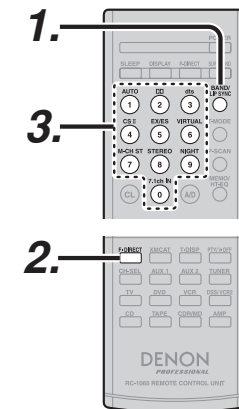

1. To select tuner and desired band (FM or AM), press the **BAND** button on the remote.
2. Press the **F.DIRECT** on the remote, display will show "FREQ - - - -".
3. Input your desired station's frequency with the **numeric** buttons on the remote.
4. The desired station will automatically be tuned.

(FM) TUNING MODE (AUTO STEREO OR MONO)

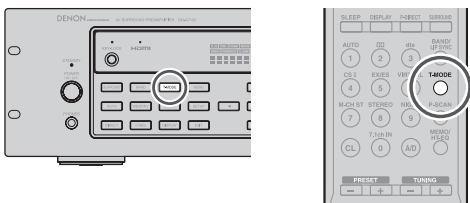

When in the auto stereo mode, **AUTO** indicator will be illuminated on the display.

The **"ST"** indicator is illuminated when a stereo broadcast is tuned in.

At open frequencies, the noise is muted and the **"TUNED"** and **"ST"** indicators are not illuminated.

If the signal is weak, it may be difficult to tune into the station in stereo. In such a case, press the **T-MODE** button on the front panel or remote.

"AUTO" indicator is not illuminated, if FM stereo broadcasts are received in monaural and the **"ST"** indicator is not illuminated.

To return to auto stereo mode, press the **T-MODE** button or press **T-MODE** button on the remote again. **AUTO** indicator is illuminated on the display.

PRESET MEMORY

With this unit you can preset up to 50 FM/AM stations in any order.

For each station, you can memorize the frequency and reception mode if desired.

AUTO PRESET MEMORY

This function automatically scans the FM and AM band and enters all stations with proper signal strength into the memory.

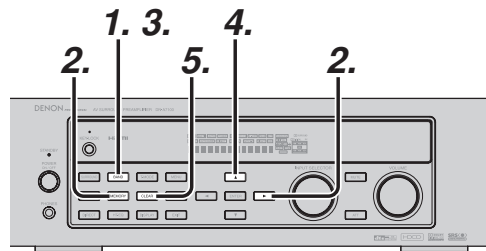

1. To select FM, press the **BAND** button on the front panel.

2. While pressing the **MEMORY** button, press the **▶** cursor button.

"AUTO PRESET" will appear on the display, and scanning starts from the lowest frequency.

3. Each time the tuner finds a station, scanning will pause and the station will be played for five seconds.

During this time, the following operations are possible.

The band can be changed by the **BAND** button.

4. If no button is pressed during this period, the current station is memorized in location Preset 02.

If you wish to skip the current station, press the **▲** cursor button during this period, this station is skipped and auto presetting continues.

5. Operation stops automatically when all 50 preset memory positions are filled or when auto scanning attains the highest end of all bands. If you desire to stop the auto preset memory at anytime, press the **CLEAR** button.

MANUAL PRESET MEMORY

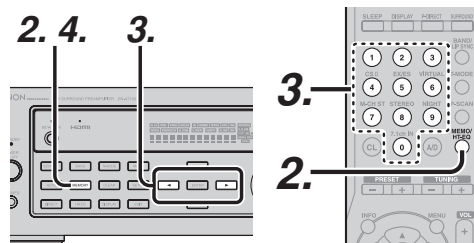

(Using the **DN-A7100**)

1. Tune into the radio station you desire (Refer to the **"MANUAL TUNING"** or **"AUTO TUNING"** section).

2. Press the **MEMORY** button on the front panel. **"- -"** (preset number) starts blinking on the display.

3. Select the preset number by pressing the **◀** or **▶** cursor buttons, while this is still blinking (approx. 5 seconds)

4. Press the **MEMORY** button again to enter. The display stops blinking.

The station is now stored in the specified preset memory location.

(Using the **remote control unit**)

1. Tune into the radio station you desire (Refer to the **"MANUAL TUNING"** or **"AUTO TUNING"** section).

2. Press the **MEMO** button on the remote. **"- -"** (preset number) starts blinking on the display.

3. Enter the desired preset number by pressing the **numeric** buttons.

Note:

When entering a single digit number (2 for example), either input "02" or just input "2" and wait for a few seconds.

RECALLING A PRESET STATION

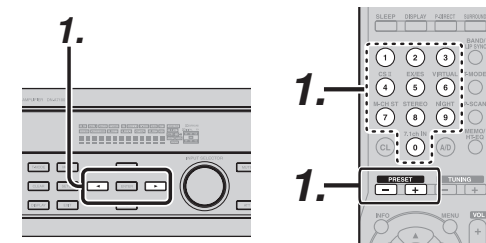

(Using the **DN-A7100**)

1. Select the desired preset station by pressing the **◀** or **▶** cursor buttons on the front panel

(Using the **remote control unit**)

1. Press the **PRESET +/-** buttons to select the desired preset station, or input your desired preset channel with the **numeric** buttons on the remote.

PRESET SCAN

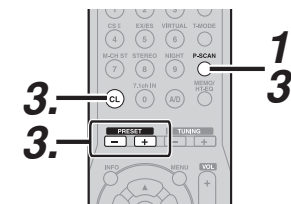

(Using the **remote control unit**)

1. Press the **P-SCAN** on the remote.

"PRESET SCAN" appears on the display and then the preset station with the lowest preset number is recalled first.

2. Preset stations are recalled in sequence (No.1 → No.2 → etc.) for 5 seconds each.

No stored preset number will be skipped.

3. You can fast forward the preset stations by pressing the **PRESET +/-** continuously.

When the desired preset station is received, cancel the preset scan operation by pressing the **CL** button or **P-SCAN** on the remote.

CLEARING STORED PRESET STATIONS

You can remove preset stations from the memory using the following procedure.

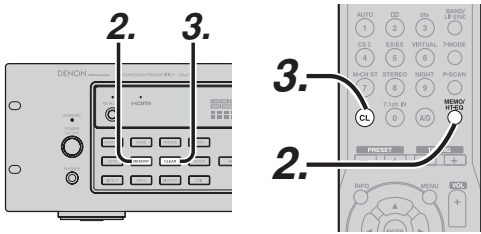

1. Recall the preset number to be cleared with the method described in "Recalling" a preset station.
2. Press the **MEMORY** button on the front panel or press the **MEMO** button on the remote.
3. The stored preset number blinks in the display for 5 seconds. While blinking, press the **CLEAR** button on the front panel or press the **CL** button on the remote.
4. "**xx CLEAR**" appears on the display to indicate that the specified preset number has been cleared.

Note:

To clear all stored preset stations, press and hold the **CLEAR** and the **ENTER** buttons for two seconds.

SORTING PRESET STATIONS

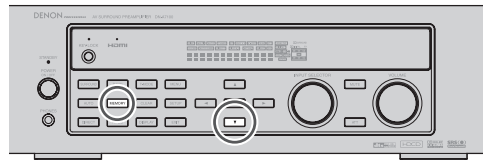

If you have stations memorized, and there is a gap in the sequential order:

i.e. the stations are stored as follows

- 1) 87.1 MHz
- 2) 93.1 MHz
- 3) 94.7 MHz
- 10) 105.9 MHz

(notice there is no stations programmed for pre sets for 4-9), you can have pre set 10 become pre set 5: To sort the numbers, press and hold the **MEMORY** and the **▼** cursor buttons. "**PRESET SORT**" will appear on the display and sorting will be done.

NAME INPUT OF THE PRESET STATION.

This function allows the name of each preset channel to be entered using alphanumeric characters.

Before name inputting, you need to store preset stations with the preset memory operation.

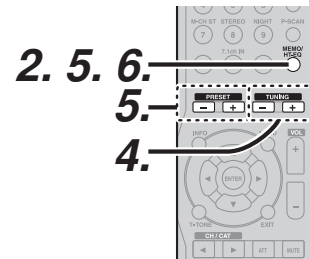
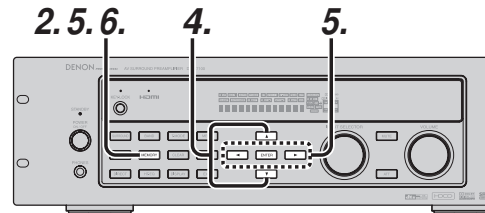

1. Recall the preset number to be inputted name with the method described in "Recalling" a preset station.
2. Press the **MEMORY** button on the front panel or press the **MEMO** button on the remote for more than 3 seconds.
3. The left most column of the station name indicator flashes, indicating the character entry ready status.
4. When you press the **▲** or **▼** cursor buttons on the front panel or the **TUNING +/-** buttons on the remote, alphabetic and numeric characters will be displayed in the following order:
A → B → C ... Z → 1 → 2 → 3 0 → - → + → / → (Blank) → A

UP →
 ← DOWN

5. After selecting the first character to be entered, press the **MEMORY** or **ENTER** buttons, press the **MEMO** button on the remote.

The entry in this column is fixed and the next column starts to flash. Fill the next column the same way.

To move back and forth between the characters, press the **◀/▶** cursor buttons or press **PRESET -/+** buttons on the remote.

Note:

Unused columns should be filled by entering blanks.

6. To save the name, press the **MEMORY** button on the front panel or remote for more than 2 seconds.

Ten keypad	Press, press again, press again, etc.
1	A → B → C → 1 → A
2	D → E → F → 2 → D
3	G → H → I → 3 → G
4	J → K → L → 4 → J
5	M → N → O → 5 → M
6	P → Q → R → 6 → P
7	S → T → U → 7 → S
8	V → W → X → 8 → V
9	Y → Z → space → 9 → Y
0	- → + → / → 0

RDS OPERATION

Now in use in many countries, RDS (Radio Data System) is a description of the station's programming hidden space in the FM signal.

Your new receiver is equipped with RDS to assist in the selection of FM stations using station and network names, rather than broadcast frequencies. Additional RDS functions include the ability to search for programme types.

RADIO TEXT

Some RDS stations broadcast RADIO TEXT, which is additional information on the station and programme being broadcast.

RADIO TEXT information appears as 'running' text in the display. RADIO TEXT is transmitted character by the radio station. As a result of that it may take some time until the entire text has been completely received.

RDS DISPLAY

When a receiver is tuned to an FM station that is transmitting RDS data, the Front Panel Information Display will automatically show the station name or RADIO TEXT in place of the typical display of the station's broadcast frequency.

To change the display, press the **T-DISP** button on the remote.



PROGRAMME TYPE (PTY) DISPLAY

The RDS system categorizes programmes according to their genre into different programme type (PTY) groups. To display the programme type information of the current station, press the **PTY** button in the TUNER MODE on the remote.



PTY AUTO SEARCH

Your receiver is equipped to automatically search for stations transmitting any of 29 different programme types. To search for a PTY, follow these procedures:

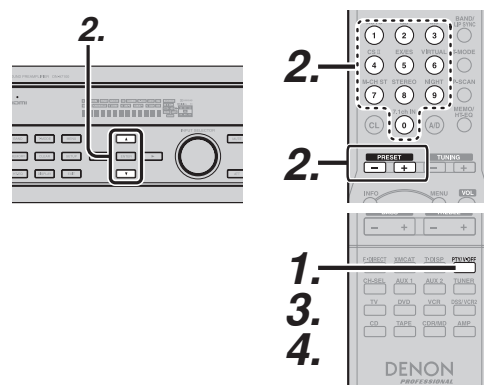

1. Press the **PTY** button in the TUNER MODE on the remote controller. The current station's PTY will be displayed, or the currently selected PTY group will be displayed in blinking if no station or RDS data is present.
2. To change to a new PTY type, press the **▲** or **▼** cursor button on the front panel or **numeric** or **PRESET -/+** buttons on the remote until the desired PTY is shown in the display.

3. Once the desired PTY group or type has been selected, press the **PTY** button while the display blink (approx. 5 seconds). The PTY Auto search will start, and the tuner will pause at each station broadcasting RDS PTY information corresponding to the selected choice.
4. To advance to the next RDS station with the desired PTY, press the **PTY** button again within 5 seconds.

NUMBER	DISPLAY	PROGRAMME TYPE
1	POP	Pop Music
2	ROCK	Rock Music
3	MOR	M. O. R. Music
4	LIGHT	Light classical
5	CLASSIC	Serious classical
6	NEWS	News
7	AFFAIR	Current Affairs
8	INFO	Information
9	SPORT	Sport
10	EDUCATE	Education
11	DRAMA	Drama
12	CULTURE	Culture
13	SCIENCE	Science
14	OTHERS	Varied
15	OTHER	Other Music
16	WEATHER	Weather
17	FINANCE	Finance
18	CHILDREN	Children's programmes
19	SOCIAL	Social Affairs
20	RELIGION	Religion
21	PHONE IN	Phone In
22	TRAVEL	Travel
23	HOBBIES	Hobbies
24	JAZZ	Jazz Music
25	COUNTRY	Country Music
26	NATION	National Music
27	OLDIES	Oldies Music
28	FOLK	Folk Music
29	DOCUMENT	Documentary

TROUBLESHOOTING

In case of trouble, check the following before calling for service:

1. Are the connections made properly ?
2. Are you operating the unit properly following the user's guide ?
3. Are the power amplifiers and speaker working properly ?

If the unit does not operate properly, check items shown in the following table.
If your trouble cannot be recovered with the remedy actions listed in the following table, malfunction of the internal circuitry is suspected; immediately unplug the power cable and contact your dealer, nearest DENON authorized dealer or the DENON Service Center in your country.

SYMPTOM	CAUSE	REMEDY
DN-A7100 cannot be turned up.	The power plug is not connected.	Connect the power plug to the outlet.
No sound and picture are output even when power is on.	Mute is on.	Cancel mute using the remote control unit.
	The input cable is not connected correctly.	See the connection diagram and connect the cables correctly.
	The master volume control is turned all the way down.	Adjust the master volume.
	The SOURCE position is wrong.	Select correct position.
Incorrect Audio or Video for selected source.	Input cable connected incorrectly.	Connect the cable correctly by referring to the connection diagram.
Incorrect Audio from a channel.	Speaker cable connected incorrectly.	Connect the cable correctly by referring to the connection diagram.
No Audio output from the center channel speaker.	The center speaker cable connection is incomplete.	Connect the cable correctly.
	STEREO has been selected for Surround mode.	When STEREO is selected for Surround mode, no sound will be output from the center speaker. Set another Surround mode.
	Center = NONE has been selected in SETUP mode.	Make the correct setting.
No Audio output from the surround speakers.	The surround speaker cable connection is incomplete.	Connect the cable correctly.
	STEREO has been selected for Surround mode.	When STEREO has been selected for Surround mode, no sound will be output from the surround speaker. Set another Surround mode.
	Surround = NONE has been selected in SETUP mode.	Make the correct setting.
No Audio output from the surround back speakers.	The surround back speaker cable connection is incomplete.	Connect the cable correctly.
	Surround mode is not EX/ES mode.	Set surround mode EX/ES.
	Surround back = NONE has been selected in SPEAKERS SIZE SETUP	Make the correct setting.

SYMPTOM	CAUSE	REMEDY
Can not select EX/ES mode.	Surround center= NONE has been selected in SPEAKERS SIZE SETUP	Make the correct setting.
	Input signal is incompatible.	Use 5.1channel source.
Can not select Pro Logic IIx mode.	Input signal is incompatible.	Use 2 channel Dolby Digital input signal, PCM input signal or analog input signal.
Can not select Neo:6 mode.	Input signal is incompatible.	Use 2 channel Dolby Digital input signal, PCM input signal or analog input signal.
Can not select CSII mode.	Input signal is incompatible.	Use 2 channel Dolby Digital input signal, PCM input signal or analog input signal.
No output to Sub Woofer Out.	Sub-woofer = NONE has been selected in SETUP mode.	Select Sub-woofer = YES.
Noise is produced during DTS-encoded CD or laser disc play.	Analog has been selected for input.	Be sure to perform digital connection, select digital input, then play.
A specific channel does not produce output.	Nothing recorded on source.	Check the encoded channel on the source side.
FM or AM reception fails.	Antenna connection is incomplete.	Correctly connect the indoor FM and AM antennas to FM and AM antenna outlets.
Noise is heard during AM reception.	Reception is affected by other electrical fields.	Try changing location where the AM indoor antenna is set up.
Noise is heard during FM reception.	The radio waves from the broadcasting station are weak.	Install an FM outdoor antenna.
Cannot get programmed station when the PRESET button is pressed.	Preset data has been erased.	Disconnecting power plug for long periods of time will erase preset data. If that happens, input the preset data again.
Control with the remote control unit fails.	Batteries are consumed.	Replace all the batteries with new ones.
	Remote controller's function-key setting is wrong.	Select different position from which equipment will be controlled.
	The distance between this DN-A7100 and the remote commander is too far.	Move closer to this DN-A7100.
	Something is blocking DN-A7100 and the remote commander.	Remove offending object.

Note:

After "PROTECT" appears on the unit's display, the standby indicator may start flashing. If it does, there is a problem in the unit or the connection. If this problem reoccurs even when power is activated from the remote control unit, call for servicing.

RS-232C CONTROL SPECIFICATION

GLOBAL DESCRIPTION

OVERVIEW

A Host controller can control or watch out the product as a Slave very easily via the communication cable.

BLOCK DIAGRAM

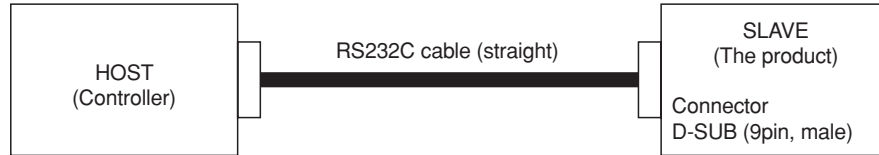

* The product connector is using D-SUB 9pin male.

* RS232C cable must use D-SUB 9pin female to connect the products.

INTERFACE CONNECTION SPECIFICATION OF THE PRODUCT

Processor Interface	Signal name	Connection device	D-Sub Pin	Connector
-	N.C.	-	1	RS232C D-SUB (9pin,male)
UART	TxD (output)	RS232C Level shift driver	2	
	RxD (input)		3	
-	N.C.	-	4	
-	GND	GND	5	
-	N.C.	-	6	
-	N.C.	-	7	
-	N.C.	-	8	
-	N.C.	-	9	

DETAILED DESCRIPTION

The interface specification between the product and a Host controller is described below.

CONNECTION FORMAT

Physical connection

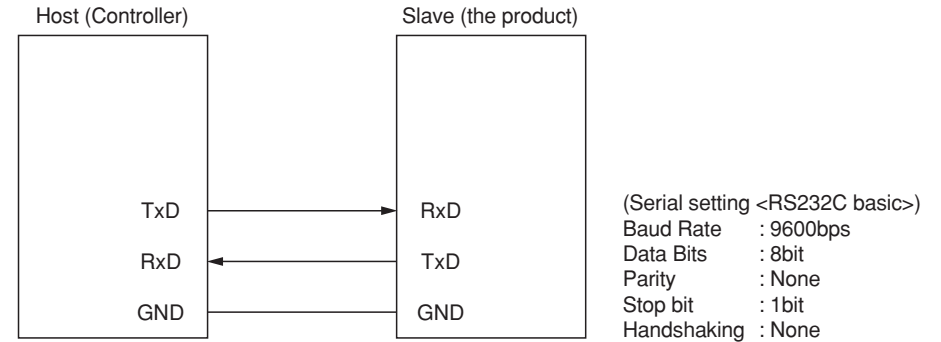

Data transmission sequence from Host to Slave

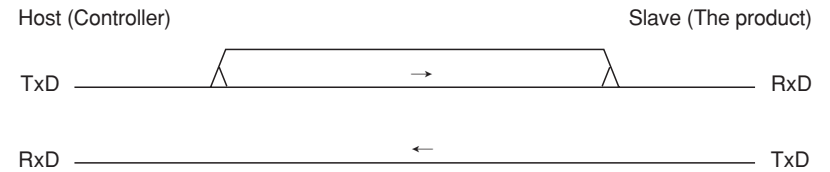

1. Host starts a data transmission from TxD.
2. Host performs the data transmission of the number of required bytes, and ends a transmission.

Data transmission sequence from Slave to Host

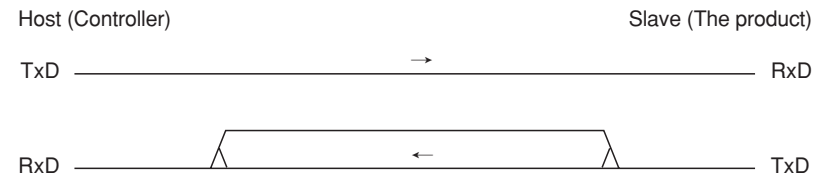

1. Slave starts a data transmission from TxD.
2. Slave performs the data transmission of the number of required bytes, and ends a transmission.

TRANSMISSION DATA FORMAT**Transmission data format from Host to Slave**

There are two kinds of transmission data form from Host shown below.

- **Form1: Command**

Command is a data that requests some status change.

Start character : '@'
 COMMAND : see "Command list"
 End character (CR) : 0Dh

start	command	end
'@'	"xxx:"+"..."	0Dh

- **Form2: Status request**

Status request is a data that requests a answer of some status.

Start character : '@'
 Request status : see "Status request list"
 Request character : '?'
 End character (CR) : 0Dh

start	request status	end
'@'	"xxx:?"+"..."	0Dh

Transmission data format from Slave to Host

There are two kinds of transmission data form from Slave shown below.

- **Form1: ACK/NAK**

ACK is a reply data from Slave when Slave got an acceptable command data from Host.
 (ACK is sent to Host when Slave has no related status by the Command.)

Start character : '@', ACK : 06h, End character (CR) : 0Dh

start	ACK	CR
'@'	06h	0Dh

NAK is a reply data from Slave when Slave got an incorrect Command data, Status request data or some other data from Host.

Start character : '@', NAK : 15h, End character (CR) : 0Dh

start	NAK	CR
'@'	15h	0Dh

- **Form2: Status answer and Auto status feedback**

Status answers are reply data when Slave got an acceptable Request status or Command data from Host.
 Auto status feedbacks are send to Host data when a Slave's status is changed.

Start character : '@'
 Answer character : see "Status list"
 End character (CR) : 0Dh

start	status	end
'@'	"xxx:"+"..."	0Dh

THE TRANSACTION SEQUENCES AND THE REGULATIONS**The transaction sequences**

The transactions have three kinds of sequence.

- * A transaction is a Command from Host then Slave will be an answer by Status answer, ACK or NAK.
- * A transaction is a Status request from Host then Slave will be an answer by Status answer or NAK.
- * A transaction is Auto status feedback from Slave when a Slave's status changed. (If the auto status feedback is enabled.)

The transaction regulations

The transactions have some kinds of regulation.

- * An answer (ACK, NAK or Status answer) transmission by Slave has to finish within 500ms when got a Command or a Status request from Host.
- * Host must not transmit an another Command or Status request until "it receives a answer by a previous Command or Status request" or "it passes a term of waiting time from a finishing of previous transmission of a Command or a Status request".
- * Slave has to finish a transaction under 500ms when it sends Auto status feedback data.

Specification of Auto status feedback

There are some specific regulations about Auto status feedback.

- * The product status has segmented into **four layers of 1, 2, 3 and 4**.
- * The status of layer 1 are assigned most kindly status to Host. (The statuses of layer 2 are assigned kindly status, the statuses of layer 3 are not so need status to Host and the statuses of layer 4 are probably no wished statuses.)
- * Each layer status can control transmit enable or disable by Host command. (The product default would be all disables.)
- * Slave sends auto status feedback by itself when the status is changed and if the status feedback is enabled.
- * The product defined and segmentated layers are taking in status list.

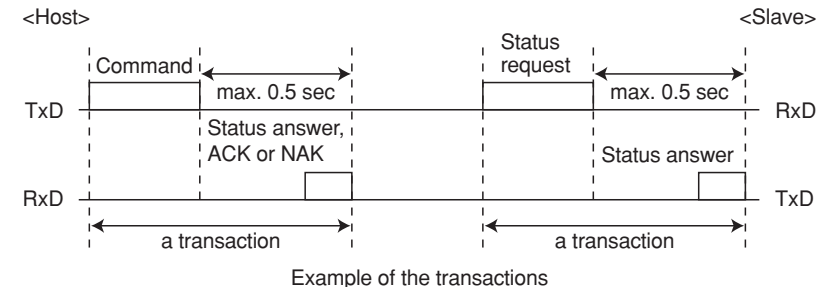
Example of the transactions

Examples of the handshaking flowchart

• **Example of successful handshaking**

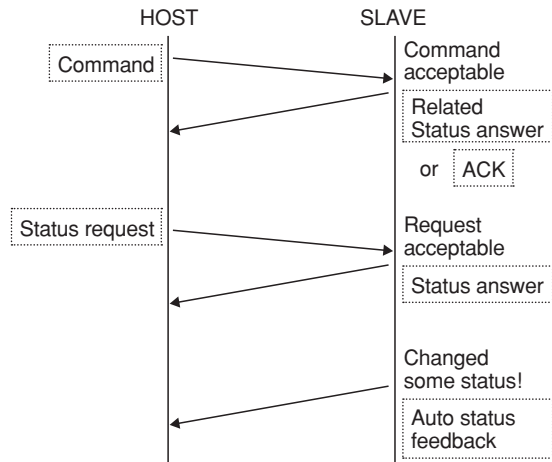

The product can reply ACK instead of related status, if the product can not send the related status immediatly.

• **Examples of handshaking error**

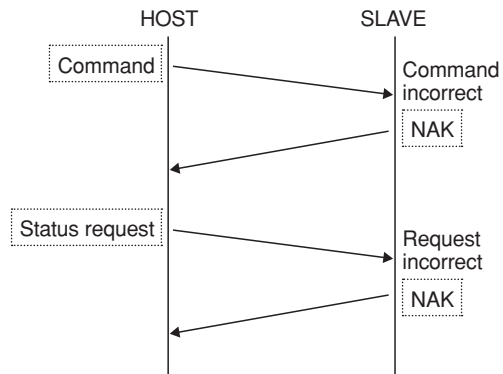

RECOMMENDATIONS OF COMMAND, STATUS AND LAYER DEFINITION

- All Commands, Statuses and Layers will be defined other specific document.
- **[MANDATORY]** The product **MUST** have Commands and the Statuses same as a remote controller buttons (IR controller) of the product.
- All commands are required working by discrete as ON/OFF commands. (It means that do not support TOGGLE command only.)
- All Commands and Statuses are defined same character size except ACK/NAK on the product. (Recommended character length : 3~6 characters)
- It permits attaching 0x0A character to reply characters from the product. In this case, must suppose that the object is followed altogether.
- Recommend to supports numbers or values direct setting command, if it has variable numbers or values.

RECOMMENDATIONS OF COMMAND, STATUS AND LAYER

This section is told how to define "Command", "Status" and "Layer" of this product.

Normal Command list

Main function contents

Command		Reply from Slave
POWER	TOGGLE	"PWR:0"
	OFF	"PWR:1"
	ON	"PWR:2"
AUDIO ATT	TOGGLE	"ATT:0"
	OFF	"ATT:1"
	ON	"ATT:2"
AUDIO MUTE	TOGGLE	"AMT:0"
	OFF	"AMT:1"
	ON	"AMT:2"
VIDEO MUTE	TOGGLE	"VMT:0"
	OFF	"VMT:1"
	ON	"VMT:2"
VOLUME	VALUE	"VOL:0xxx"
	UP	"VOL:1"
	DOWN	"VOL:2"
TONE BASS	VALUE	"TOB:0xxx"
	UP	"TOB:1"
	DOWN	"TOB:2"
TONE TREBLE	VALUE	"TOT:0xxx"
	UP	"TOT:1"
	DOWN	"TOT:2"
SOURCE Select	TV	"SRC:1"
	DVD	"SRC:2"
	VCR1	"SRC:3"
	DSS/VCR2	"SRC:5"
	AUX1	"SRC:9"
	AUX2	"SRC:A"
	CD	"SRC:C"
	CD-R	"SRC:D"
	TAPE	"SRC:E"
	TUNER	"SRC:F"
	FM	"SRC:G"
AM	"SRC:H"	
7.1 Channel Input	TOGGLE	"71C:0"
	OFF	"71C:1"
	ON	"71C:2"

Display and Menu contents

Command		Reply from Slave
SLEEP	VALUE	"SLP:0xx" (xx=00~99)
	OFF	"SLP:1"
MENU	TOGGLE	"MNU:0"
	OFF(EXIT)	"MNU:1"
	ON	"MNU:2"
	ENTER	"MNU:3"
CURSOR	UP	"CUR:1"
	DOWN	"CUR:2"
	LEFT	"CUR:3"
	RIGHT	"CUR:4"

Command		Reply from Slave
DC TRG.	TRG.1 OFF	"DCT:11" (DC TRG. 1 OFF)
	TRG.1 ON	"DCT:12" (DC TRG. 1 ON)

Command		Reply from Slave
Simple Setup	TOGGLE	"SSU:0"
	OFF(EXIT)	"SSU:1"
	ON	"SSU:2"
	ENTER	"SSU:3"
CURSOR (same as Menu Cursor)	UP	"CUR:1"
	DOWN	"CUR:2"
	LEFT	"CUR:3"
	RIGHT	"CUR:4"

Surround contents

Command		Reply from Slave
Surr. Mode	AUTO	"SUR:00"
	STEREO	"SUR:01"
	DOLBY	"SUR:02"
	PL2xMOVIE	"SUR:03"
	PL2 MOVIE	"SUR:04"
	PL2xMUSIC	"SUR:05"
	PL2 MUSIC	"SUR:06"
	PL2xGAME	"SUR:07"
	PL2 GAME	"SUR:08"
	Dolby PROLOGIC	"SUR:09"
	EX/ES	"SUR:0A"
	VIRTUAL 6.1	"SUR:0B"
	-	-
	DTS ES	"SUR:0E"
	NEO6 CINEMA	"SUR:0F"
	NEO6 MUSIC	"SUR:0G"
	Multi Ch. STEREO	"SUR:0H"
	CSII CINEMA	"SUR:0I"
	CSII MUSIC	"SUR:0J"
	CSII MONO	"SUR:0K"
	VIRTUAL	"SUR:0L"
	DTS	"SUR:0M"
	DD+ PL2x MOVIE	"SUR:0O"
	DD+ PL2x MUSIC	"SUR:0P"
	-	-
	SOURCE DIRECT	"SUR:0T"
	PURE DIRECT	"SUR:0U"
	UP	"SUR:1"
	DOWN	"SUR:2"

"SUR:x"
(x = '0' ~ 'Z')

Tuner contents

Command		Reply from Slave
Tuner Frequency	VALUE	"TFQ:0xxxx" (xxxx = freq.)
	UP	"TFQ:1"
	DOWN	"TFQ:2"
	Auto-UP	"TFQ:3"
Auto-DOWN	"TFQ:4"	"TFQ:xxxx" (xxxx = Frequency) if (xxxx < 02000) band=AM; else band=FM; (ex. "08750" = FM87.50MHz)
Tuner Preset	VALUE	"TPR:0ww"
	UP	"TPR:1"
	DOWN	"TPR:2"
	P-Scan start	"TPR:3"
P-Scan stop	"TPR:4"	"TPR:ww" (ww = current preset nr.) (ww = 01 ~ ??)
Tuner mode	TOGGLE	"TMD:0"
	OFF(MONO)	"TMD:1"
	ON(AUTO)	"TMD:2"
Tuner RDS	DISP	"RDS:3"
	PTY	"RDS:4"
Tuner MEMO	-	"MEM:0"
CLEAR	-	"CLR:0"
Tuner Numeric keys	Key0, Key1, Key2, Key3, Key4, Key5, Key6, Key7, Key8, Key9	"NUM:0", "NUM:1", "NUM:2", "NUM:3", "NUM:4", "NUM:5", "NUM:6", "NUM:7", "NUM:8", "NUM:9"
		ACK
		ACK
		ACK

Command		Reply from Slave
Test Tone (Force start/stop Test Tone with Auto mode)	TOGGLE	"TTO:0"
	OFF	"TTO:1"
	ON	"TTO:2"
	NEXT	"TTO:3"
PREV	"TTO:4"	"TTO:1xy" (OFF), "TTO:2xy" (ON, x= auto(0)/ manual(1), y= ch.)
Night Mode	TOGGLE	"NGT:0"
	OFF	"NGT:1"
	ON	"NGT:2"
		"NGT:1"(OFF), "NGT:2"(ON)

Command		Reply from Slave
Lip Sync.	VALUE	"LIP:0xxx" (xxx = value) xxx = 000 (OFF), xxx = 010,020,...190,200 (ms)
	UP	"LIP:1"
	DOWN	"LIP:2"
		"LIP:xxx" (xxx = Lip Sync. value) xxx = 000 (OFF), xxx = 010,020,...190.200 ms

Specific Commands

Command from Host		Reply from Slave
Auto status feedback	"AST:x" (x = '0' ~ 'F')	same as command define
(The product default is all auto status feedback disabled.)	bit 3 : Layer 4 (1 = Enable, 0 = Disable) bit 2 : Layer 3 (1 = Enable, 0 = Disable) bit 1 : Layer 2 (1 = Enable, 0 = Disable) bit 0 : Layer 1 (1 = Enable, 0 = Disable)	

STATUS REQUEST AND STATUS ANSWER LIST

Normal Status request and Status (answer and feedback) list

Status request		Status answer and feedback	
POWER	"PWR:?"	OFF	"PWR:1"
		ON	"PWR:2"
AUDIO ATT	"ATT:?"	OFF	"ATT:1"
		ON	"ATT:2"
AUDIO MUTE	"AMT:?"	OFF	"AMT:1"
		ON	"AMT:2"
VIDEO MUTE	"VMT:?"	OFF	"VMT:1"
		ON	"VMT:2"
VOLUME	"VOL:?"	Volume value = xxx	"VOL:xxx"
TONE BASS	"TOB:?"	Bass value = xxx	"TOB:xxx"
TONE TREBLE	"TOT:?"	Treble value = xxx	"TOT:xxx"
SOURCE Select	"SRC:?"	Video+Audio source (v ,a= '0' - 'F') (v = video, a = audio.)	"SRC:va"
Multi Channel	"71C:?"	OFF	"71C:1"
		ON	"71C:2"

Status request		Status answer and feedback	
SLEEP	"SLP:?"	Sleep time (xx = 00 ~ 99)	"SLP:xx"
		OFF	"MNU:1"
MENU	"MNU:?"	ON	"MNU:2"

Status request		Status answer and feedback	
Simple Setup	"SSU:?"	OFF	"SSU:1"
		ON	"SSU:2"

Status request		Status answer and feedback	
Digital Signal Format	"SIG:?"	x = '0' : No detect '1' : D DIGITAL AC-3 '2' : D DIGITAL SURROUND '3' : D DIGITAL SURR. EX '4' : DTS '5' : DTS ES DISCRETE '6' : DTS ES MATRIX '7' : AAC '8' : MPEG '9' : MLP 'A' : PCM 'B' : HDCD 'C' : DSD 'D' : reserved 'E' : reserved 'F' : OTHER	"SIG:x" x = signal

Status request		Status answer and feedback	
Lip Sync.	"LIP:?"	Lip Sync. : xxx = 000 (OFF) xxx = 010 ~ 200 (ms)	"LIP:xxx"

Status request		Status answer and feedback	
Night Mode	"NGT:?"	OFF	"NGT:1"
		ON	"NGT:2"

Status request		Status answer and feedback	
Tuner Frequency	"TFQ:?"	xxxxx = frequency if (xxxxx < 02000) band = AM; else band = FM;	"TFQ:xxxxx"
Tuner Preset	"TPR:?"	xx = preset number (01 ~ ??)	"TPR:xx"
Tuner Mode	"TMD:?"	- (None)	"TMD:0"
		OFF (MONO)	"TMD:1"
		ON (AUTO)	"TMD:2"

Layer of the statuses

Status	Layer
POWER	1
AUDIO ATT	3
AUDIO MUTE	1
VIDEO MUTE	1
VOLUME	1
TONE BASS	1
TONE TREBLE	1
SOURCE Select	1
Multi Channel	1
SLEEP	2
MENU	4
Simple Setup	4

Status	Layer
Surr. Mode	2
Test Tone	1
Night Mode	3
Signal Format	4
Lip Sync.	4

Status	Layer
Tuner Frequency	3
Tuner Preset	2
Tuner Mode	2

GENERAL MALFUNCTION

If the equipment malfunctions, this may be because an electrostatic discharge or AC line interference has corrupted the information in the equipment memory circuits. Therefore:

- disconnect the plug from the AC line supply
- after waiting at least three minutes, reconnect the plug to the AC line supply
- re-attempt to operate the equipment

Memory backup

- In case a power outage occurs or the power cord is accidentally unplugged, the DN-A7100 is equipped with a backup function to prevent memory data such as the preset memory from being erased.

HOW TO RESET THE UNIT

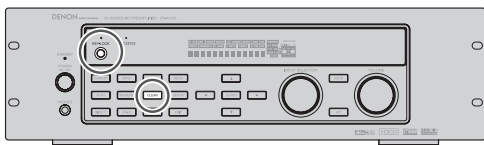

Should the operation or display seem to be abnormal, reset the unit with the following procedure.

To turn on the DN-A7100, press and hold the **CLEAR** and **KEY-LOCK** buttons simultaneously for 3 seconds or more.

Remember that the procedure will reset the settings of the SOURCE, Surround mode, delay time, TUNER PRESET etc., to their initial settings.

TECHNICAL SPECIFICATIONS

FM TUNER SECTION

Frequency Range 87.5 – 108.0 MHz
 Usable Sensitivity IHF 1.8 μV/16.4 dBf
 Signal to Noise Ratio Mono/Stereo 75/70 dB
 Distortion..... Mono/Stereo 0.2/0.3 %
 Stereo Separation..... 1 kHz 45 dB
 Alternate Channel Selectivity ± 300 kHz 60 dB
 Image Rejection..... 98 MHz 70 dB
 Tuner Output Level 1 kHz, ± 75 kHz Dev 800 mV

AM TUNER SECTION

Frequency Range 531 – 1602 kHz
 Signal to Noise Ratio 50 dB
 Usable Sensitivity Loop 400mV/m
 Distortion..... 400Hz, 30 % Mod. 0.5 %
 Selectivity..... ± 20 kHz 70 dB

AUDIO SECTION

Input Sensitivity/Impedance (volume at 0dB)
 (RCA connectors) 220 mV/ 20 kohms
 (XLR connectors)
 (+4dBu) 440 mV/ 20 kohms
 (-10dBV)..... 110 mV/ 20 kohms
 Output Level (volume at 0dB)
 (+4dBu) 300 mVrms typ.
 (-10dBV)..... 75 mVrms typ.
 Signal to Noise Ratio(Analog Input / Pure Direct)... 98 dB
 Frequency Response
 (Analog Input / Pure Direct) 10 Hz – 90 kHz (± 3 dB)
 THD 0.03 %
 Cross Talk..... 80 dB (at 1kHz)

VIDEO

Television Format..... NTSC/PAL
 Input Level/Impedance 1 Vp-p/75 ohms
 Output Level/Impedance..... 1 Vp-p/75 ohms
 Video Frequency Response 5 Hz to 8 MHz (– 1 dB)
 Video Frequency (Component)... 5 Hz to 80 MHz (– 1 dB)
 S/N 60 dB

GENERAL

Power Requirement AC 230 V 50 Hz
 Power Consumption 40 W
 Weight 7.66 Kg

ACCESSORIES

Remote Control Unit RC-1065..... 1
 AAA-size batteries 2
 FM Antenna 1
 AM Loop Antenna 1
 AC Power Cord 1
 Service Station List..... 1
 User guide 1

Specifications subject to change without prior notice.

DIMENSIONS

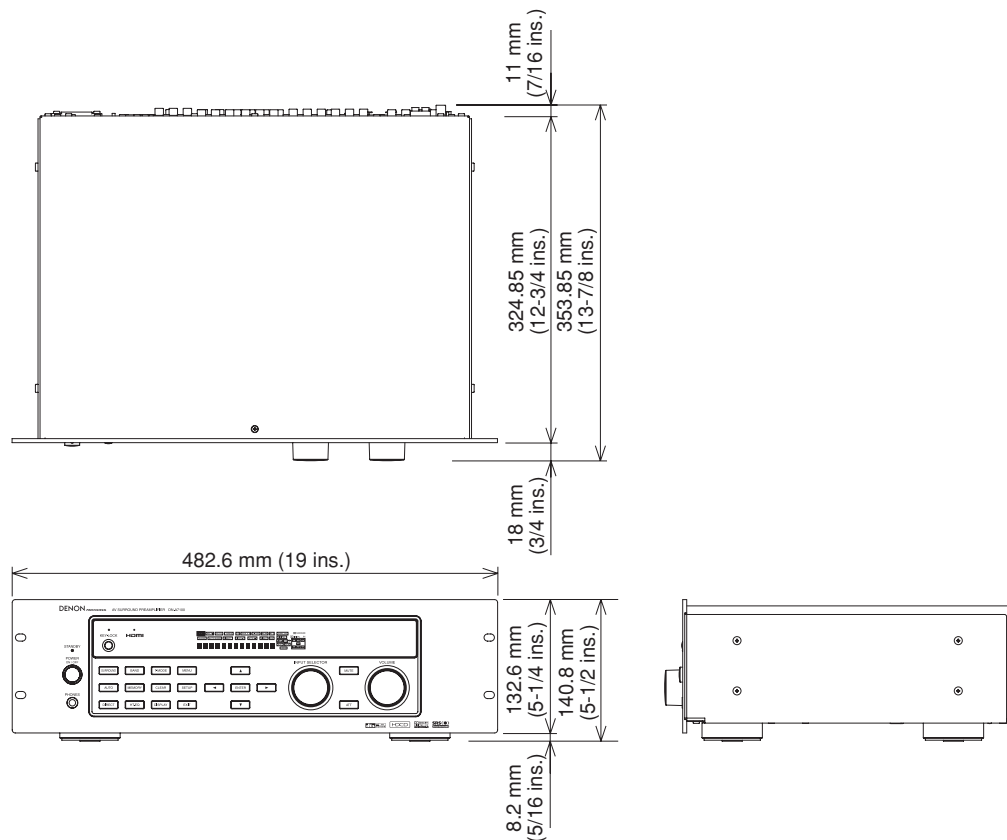

D&M Holdings Inc.

PROFESSIONAL BUSINESS COMPANY

TOKYO, JAPAN

<http://www.dm-pro.jp>



Printed in China

12/2006 00D5114595008 ecmf-d